

Package Style: QFN, 16-Pin, 0.9mm x 3mm x 3mm



Features

- Patent Pending Circuit Architecture
- Broadband 50MHz to 6000MHz Frequency Range
- 30dB Attenuation Range
- +50dBm IIP3 Typical
- +80dBm IIP2 Typical
- High 1dB Compression Point >+30dBm
- Low Supply Current 1mA Typical
- 5V Power Supply
- Linear in dB Control Characteristic
- Internal Temperature Compensation
- Class 1C ESD (1000V)
- 3.3V Version Available (RFSA2023)
- Complete Solution in a Small 3mm x 3mm, QFN Package

Applications

- Cellular, 3G Infrastructure
- WiBro, WiMax, LTE
- Microwave Radio
- High Linearity Power Control

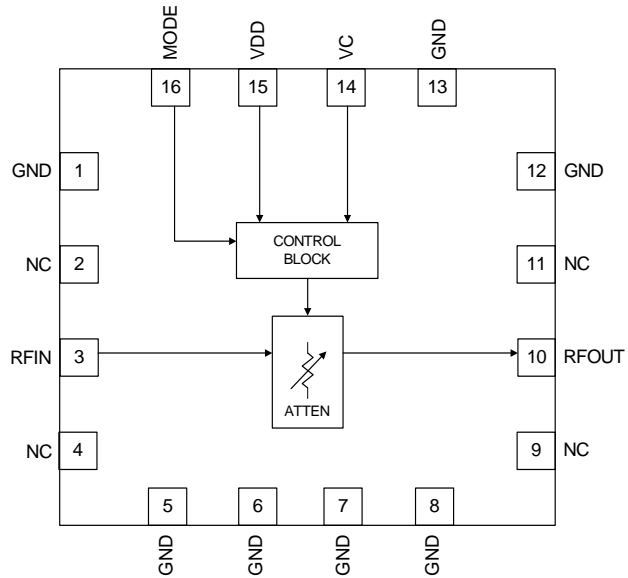

Functional Block Diagram

Product Description

RFMD's RFSA2013 is a fully monolithic analog voltage controlled attenuator (VCA) featuring exceptional linearity over a typical temperature compensated 30dB gain control range. It incorporates a revolutionary new circuit architecture to solve a long standing industry problem: high IP3, high attenuation range, low DC current, broad bandwidth and temperature compensated linear in dB control voltage characteristic. This voltage controlled attenuator is controlled by a single positive control voltage with on chip DC conditioning circuitry. The slope of the control voltage versus gain is selectable. The RFSA2013 draws a very low 1mA current and is packaged in a small 3mm x 3mm QFN. This attenuator is matched to 50Ω over its rated control range and frequency with no external matching components required. Typical VCA's in this performance category have poor inherent attenuation versus temperature and poor nonlinear attenuation versus control voltage characteristics. To correct these shortcomings, other VCA's require extensive off chip analog support circuitry that consume valuable PCB area and additional DC power. This game changing product incorporates the complete solution in a small 3mm x 3mm QFN package that reduces the footprint by 20X in area and reduces the DC power by 10X over conventional PIN diode approaches.

Ordering Information

| | |
|-----------------|---|
| RFSA2013SR | 7" Sample reel with 100 pieces |
| RFSA2013SQ | Sample bag with 25 pieces |
| RFSA2013TR7 | 7" Reel with 2500 pieces |
| RFSA2013PCK-410 | 50MHz to 6000MHz PCBA with 5-piece sample bag |

Optimum Technology Matching® Applied

- | | | | |
|--------------------------------------|--------------------------------------|---|------------------------------------|
| <input type="checkbox"/> GaAs HBT | <input type="checkbox"/> SiGe BiCMOS | <input type="checkbox"/> GaAs pHEMT | <input type="checkbox"/> GaN HEMT |
| <input type="checkbox"/> GaAs MESFET | <input type="checkbox"/> Si BiCMOS | <input checked="" type="checkbox"/> Si CMOS | <input type="checkbox"/> BiFET HBT |
| <input type="checkbox"/> InGaP HBT | <input type="checkbox"/> SiGe HBT | <input type="checkbox"/> Si BJT | |

RF MICRO DEVICES®, RFMD®, Optimum Technology Matching®, Enabling Wireless Connectivity™, PowerStar®, POLARIS™ TOTAL RADIO™ and UltimateBlue™ are trademarks of RFMD, LLC. BLUETOOTH is a trademark owned by Bluetooth SIG, Inc., U.S.A. and licensed for use by RFMD. All other trade names, trademarks and registered trademarks are the property of their respective owners. ©2012, RF Micro Devices, Inc.

Absolute Maximum Ratings

| Parameter | Rating | Unit |
|-----------------------------------|-------------|------|
| Supply Voltage (V_{DD}) | -0.5 to +6 | V |
| Control Voltage (V_C) | -0.5 to +6 | V |
| Mode Pin Voltage (MODE) | -0.5 to +6 | V |
| RF Input Power | +30 | dBm |
| Operating Temperature | -40 to +85 | °C |
| Storage Temperature | -65 to +150 | °C |
| Junction Temperature | +125 | °C |
| ESD Rating Human Body Model (HBM) | 1000 | V |



Caution! ESD sensitive device.

Exceeding any one or a combination of the Absolute Maximum Rating conditions may cause permanent damage to the device. Extended application of Absolute Maximum Rating conditions to the device may reduce device reliability. Specified typical performance or functional operation of the device under Absolute Maximum Rating conditions is not implied.

The information in this publication is believed to be accurate and reliable. However, no responsibility is assumed by RF Micro Devices, Inc. ("RFMD") for its use, nor for any infringement of patents, or other rights of third parties, resulting from its use. No license is granted by implication or otherwise under any patent or patent rights of RFMD. RFMD reserves the right to change component circuitry, recommended application circuitry and specifications at any time without prior notice.



RFMD Green: RoHS compliant per EU Directive 2002/95/EC, halogen free per IEC 61249-2-21, < 1000ppm each of antimony trioxide in polymeric materials and red phosphorus as a flame retardant, and <2% antimony in solder.

| Parameter | Specification | | | Unit | Condition |
|---|---------------|------|------|------|--|
| | Min. | Typ. | Max. | | |
| General | | | | | |
| Supply Voltage | 4.75 | 5 | 5.25 | V | |
| Supply Current | | 1 | | mA | |
| Operating Temperature | -40 | | 85 | °C | |
| Thermal Resistance | | 45 | | °C/W | RF input must be RFIN pin |
| RF Input Power | | | 27 | dBm | RF input must be RFIN pin |
| RF Performance | | | | | |
| Frequency Range | 50 | | 6000 | MHz | |
| Minimum Insertion Loss | | 2.6 | 3.5 | dB | |
| Gain Control Range | 30 | 33.2 | | dB | DC to 4GHz |
| Gain versus Temperature | | 1.7 | | dB | Peak to peak gain variation over temperature for fixed control voltage |
| Return Loss | | 15 | | dB | |
| Relative Phase | | 16.2 | | Deg | Insertion phase at 15dB attenuation relative to minimum insertion loss |
| Input 1dB Compression Point | | 30 | | dBm | |
| Input IP3 | 45 | 50 | | dBm | $PIN + (IM3_{dBc}/2)$ |
| Input IP2 | | 80 | | dBm | $PIN + IM2_{dBc}$, IM2 is F1+F2 |
| Input IH2 | | 85 | | dBm | $PIN + H2_{dBc}$, H2 is second harmonic |
| Input IH3 | | 55 | | dBm | $PIN + (H3_{dBc}/2)$, H3 is third harmonic |
| Control | | | | | |
| Voltage Control Range, Positive Attenuation Slope | 0.5 | | 4.5 | V | 4.5V control voltage is lowest insertion loss, MODE pin high |
| Voltage Control Range, Negative Attenuation Slope | 0 | | 3.3 | V | 0V control voltage is lowest insertion loss, MODE pin low |
| Voltage Control Pin Current (MODE High) | | 37 | | μA | VC Pin at 5V |
| Voltage Control Pin Current (MODE Low) | | 24 | | μA | VC Pin at 3.3V |
| MODE Pin Logic Low | | | 0.4 | V | |
| MODE Pin Logic High | 1 | | | V | |
| Settling Time | | 15 | | μsec | 1dB attenuation change settling within 0.1dB |

Note: Typical performance at nominal conditions unless otherwise noted: Supply voltage = 5.0V, Operating temperature = 25 °C, RF Frequency 2GHz

Measured Positive Attenuation Slope Performance

Data includes PCB and connector losses

Insertion Loss versus Voltage Control
RF 2GHz, $V_{DD}=5V$

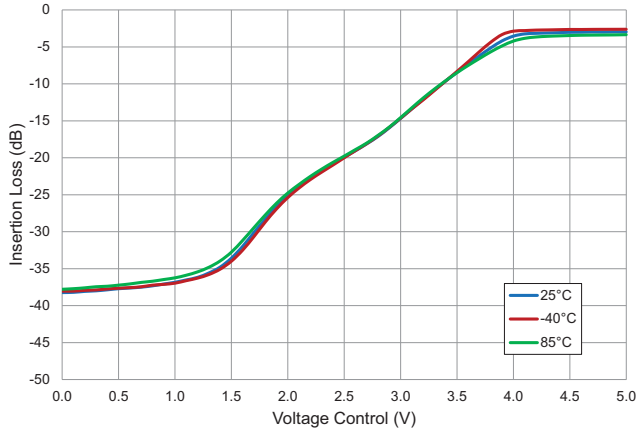

Insertion Loss versus Frequency
 $V_{DD}=5V$, Temp=+25°C

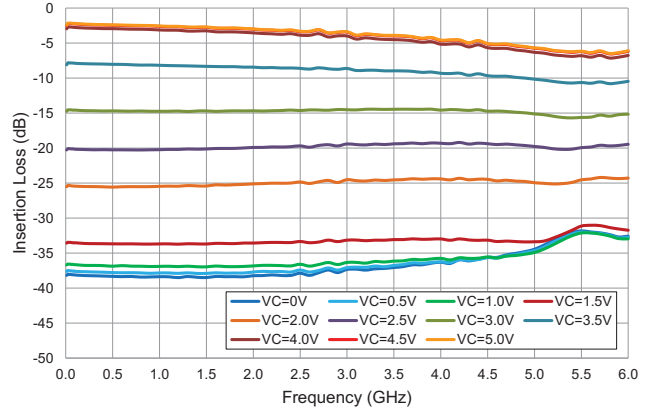

Input Return Loss versus Frequency
 $V_{DD}=5V$, Temp=+25°C

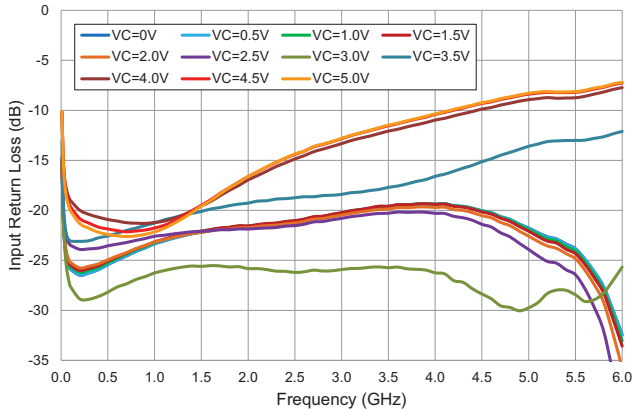

Output Return Loss versus Frequency
 $V_{DD}=5V$, Temp=+25°C

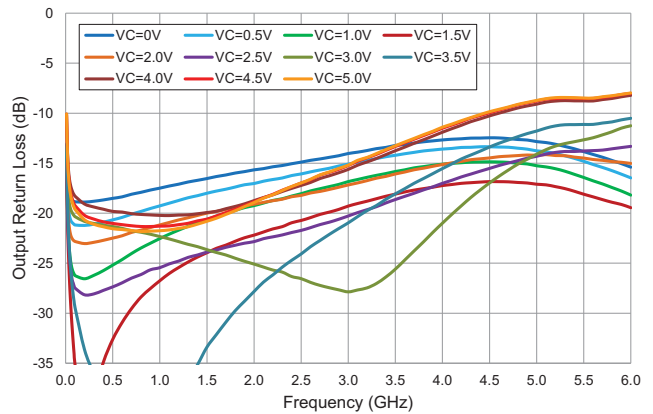

Input Return Loss versus Voltage Control
RF 2GHz, $V_{DD}=5V$

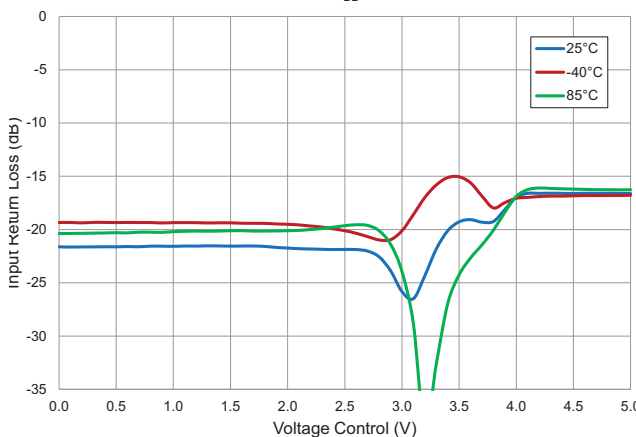

Output Return Loss versus Voltage Control
RF 2GHz, $V_{DD}=5V$

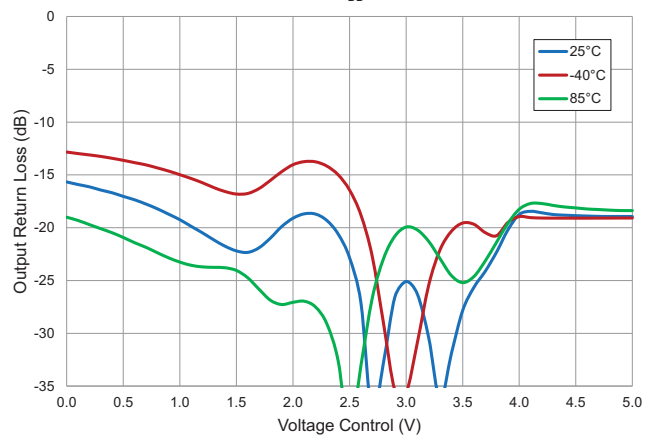

Measured Positive Attenuation Slope Performance

Data includes PCB and connector losses

Input IP3 versus Attenuation
RF 2GHz, $V_{DD}=5V$, $P_{in}=+20dBm/Tone$

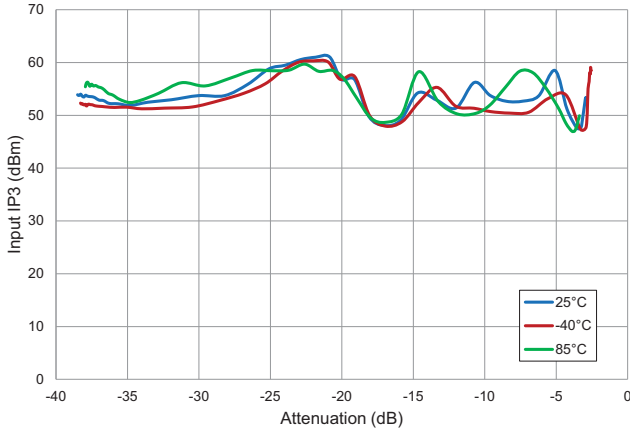

Input IP3 versus Voltage Control
RF 2GHz, $V_{DD}=5V$, $P_{in}=+20dBm/Tone$

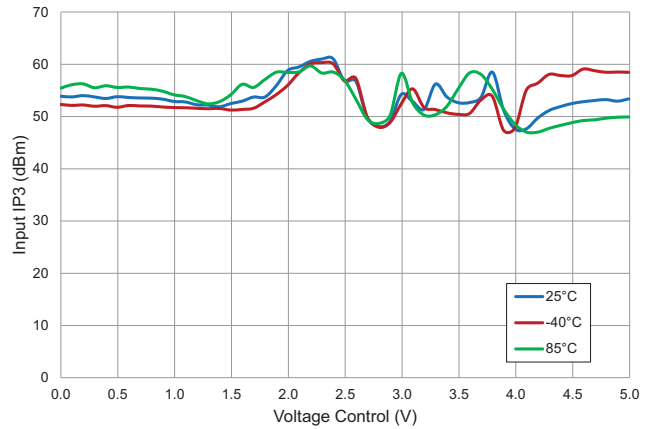

Input IP3 versus Attenuation
 $V_{DD}=5V$, $P_{in}=+20dBm/Tone$, Temp= $+25^{\circ}C$

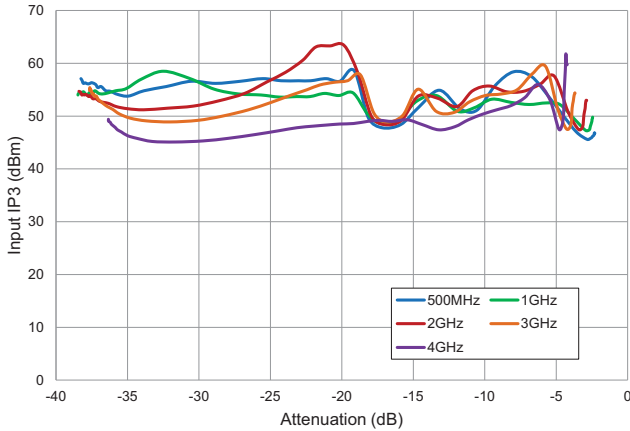

Input IP3 versus Voltage Control
 $V_{DD}=5V$, $P_{in}=+20dBm/Tone$, Temp= $+25^{\circ}C$

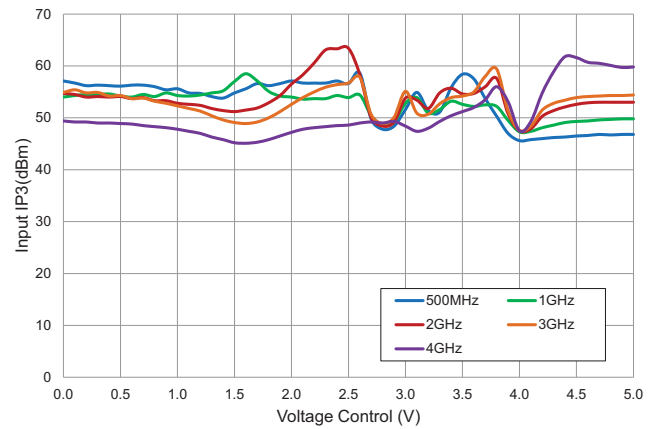

Input IP2 versus Attenuation
RF 2GHz, $V_{DD}=5V$, $P_{in}=+20dBm/Tone$

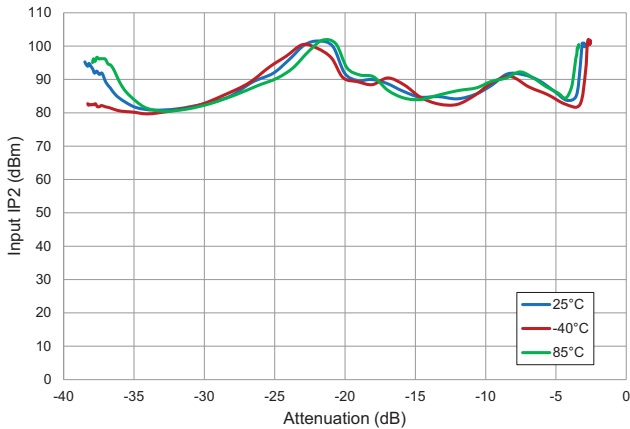

Input IP2 versus Voltage Control
RF 2GHz, $V_{DD}=5V$, $P_{in}=+20dBm/Tone$

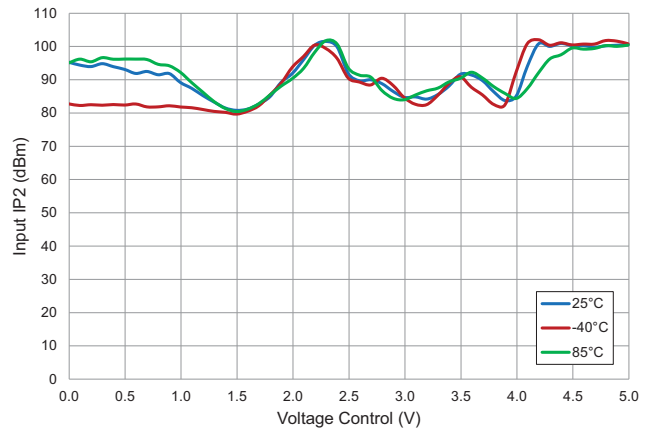

Measured Positive Attenuation Slope Performance

Data includes PCB and connector losses

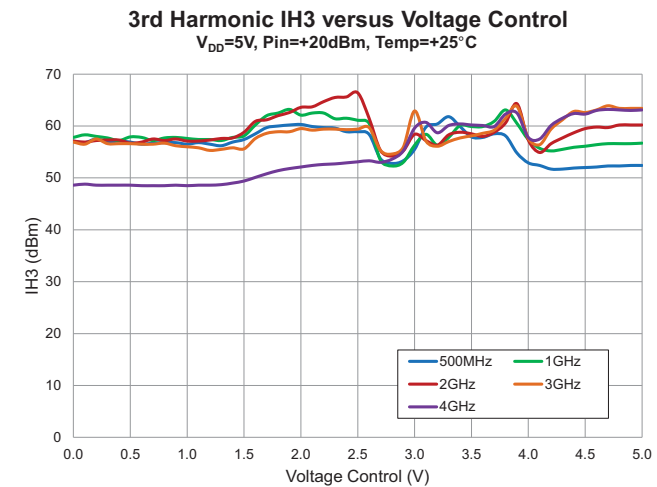
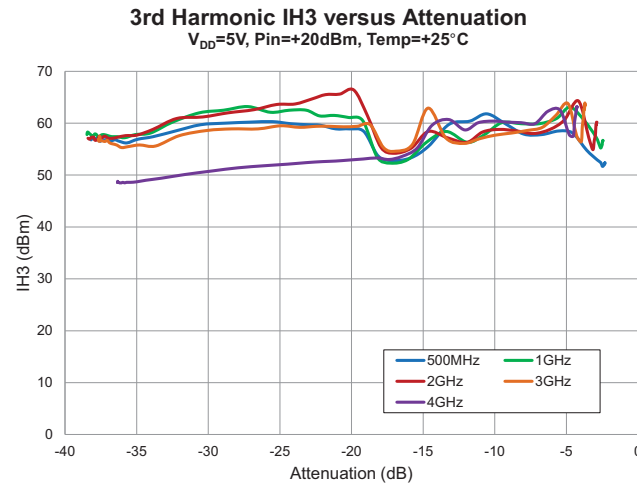
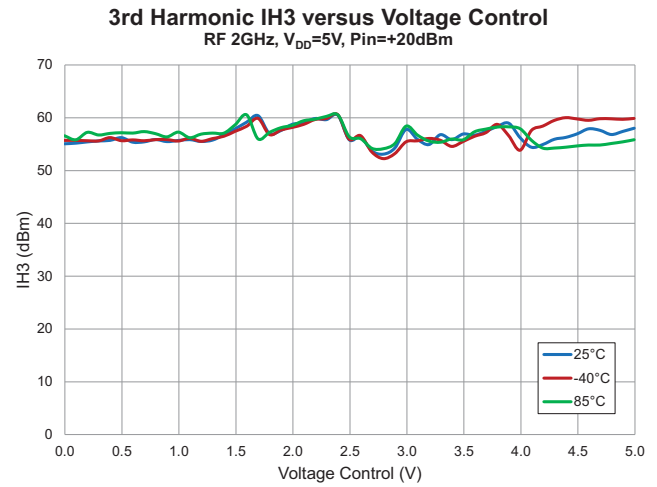
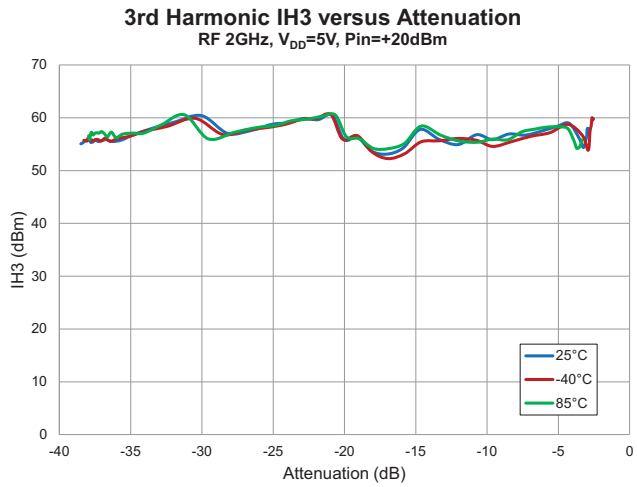
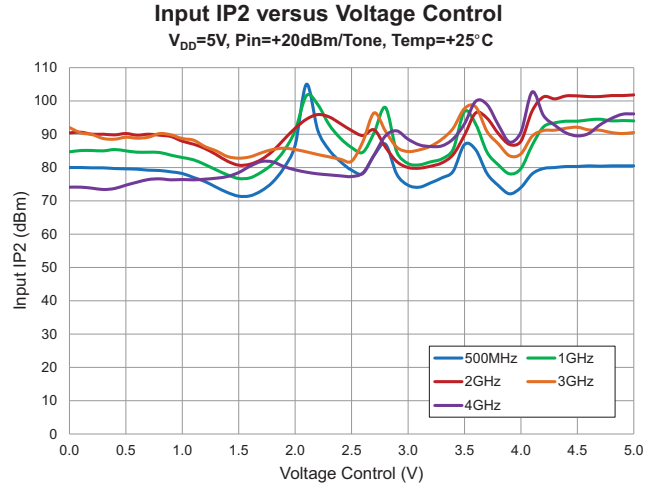
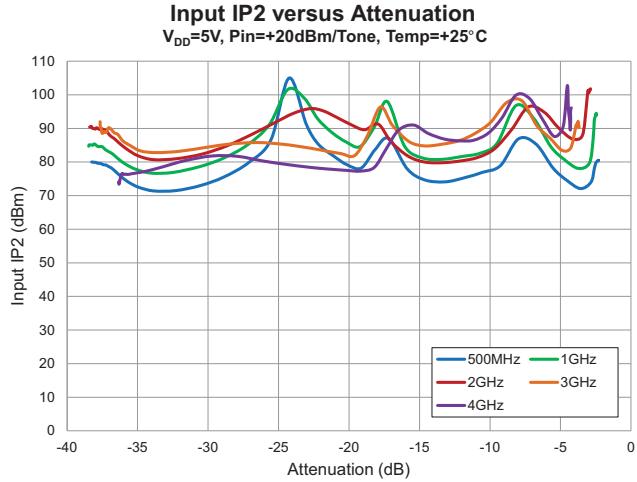

Measured Positive Attenuation Slope Performance

Data includes PCB and connector losses

2nd Harmonic IH2 versus Attenuation
RF 2GHz, $V_{DD}=5V$, $P_{in}=+20dBm$

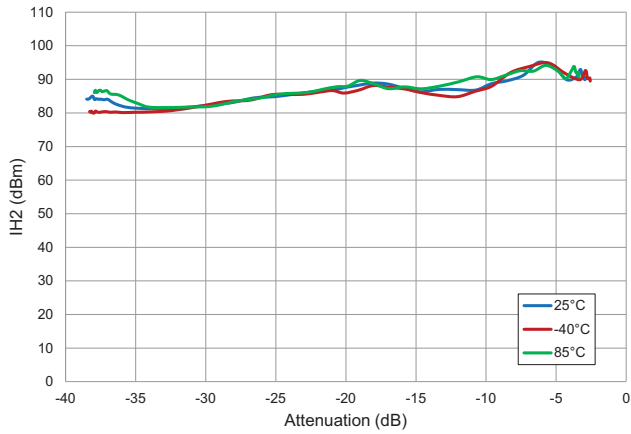

2nd Harmonic IH2 versus Voltage Control
RF 2GHz, $V_{DD}=5V$, $P_{in}=+20dBm$

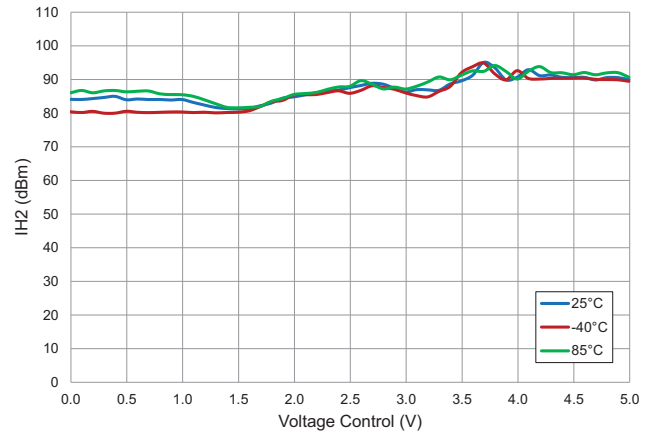

2nd Harmonic IH2 versus Attenuation
 $V_{DD}=5V$, $P_{in}=+20dBm$, Temp= $+25^{\circ}C$

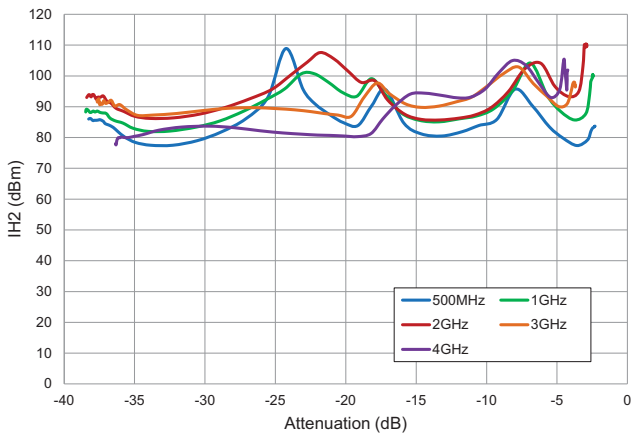

2nd Harmonic IH2 versus Voltage Control
 $V_{DD}=5V$, $P_{in}=+20dBm$, Temp= $+25^{\circ}C$

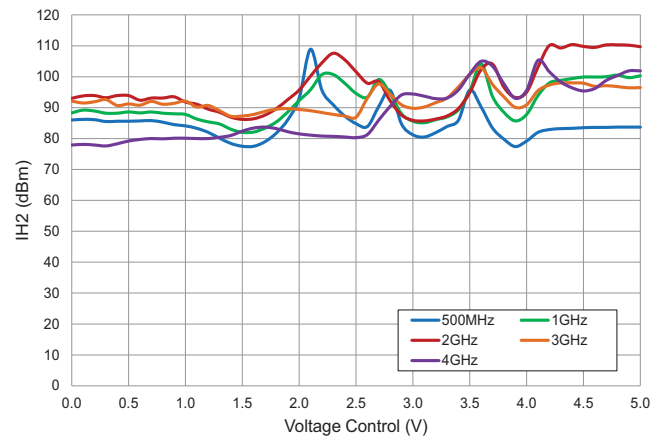

Measured Positive Attenuation Slope Performance

Data includes PCB and connector losses

Relative Insertion Phase versus Voltage Control
 $V_{DD}=5V$, Temp= $+25^{\circ}C$

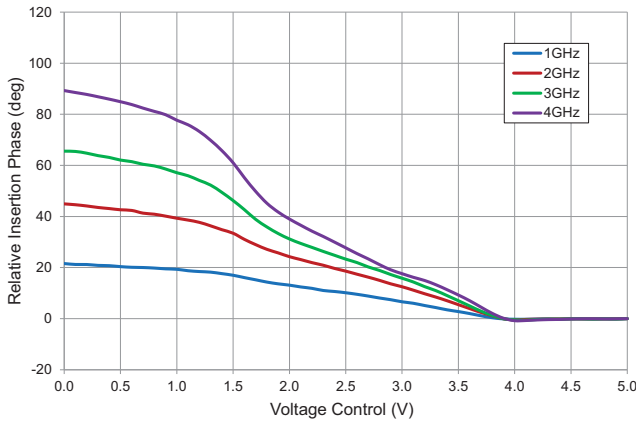

Relative Insertion Phase versus Insertion Loss
 $V_{DD}=5V$, Temp= $+25^{\circ}C$

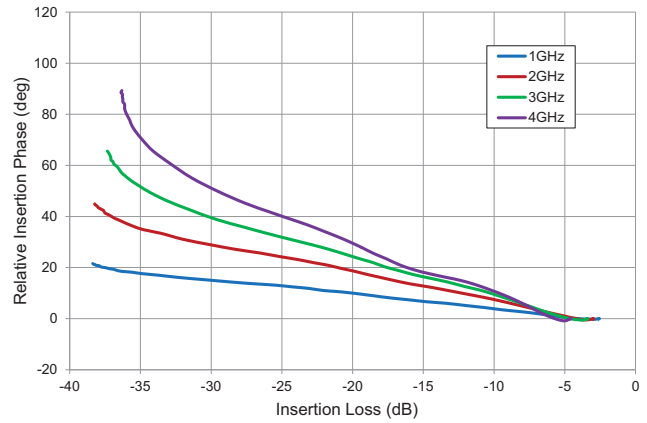

Settling Time versus Insertion Loss
 1dB Steps, RF 2GHz, $V_{DD}=5V$

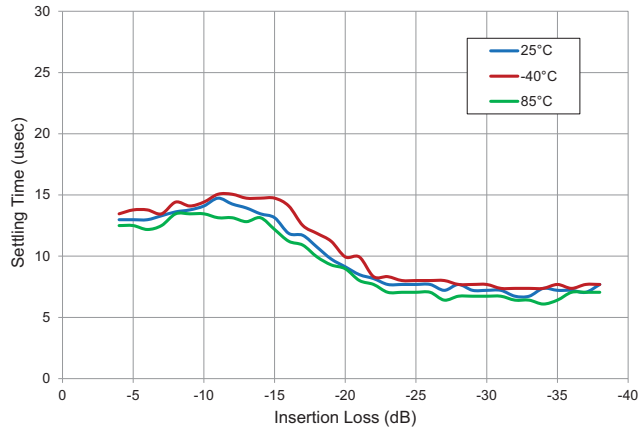

Insertion Loss Relative to $+25^{\circ}C$
 RF 2GHz, $V_{DD}=5V$

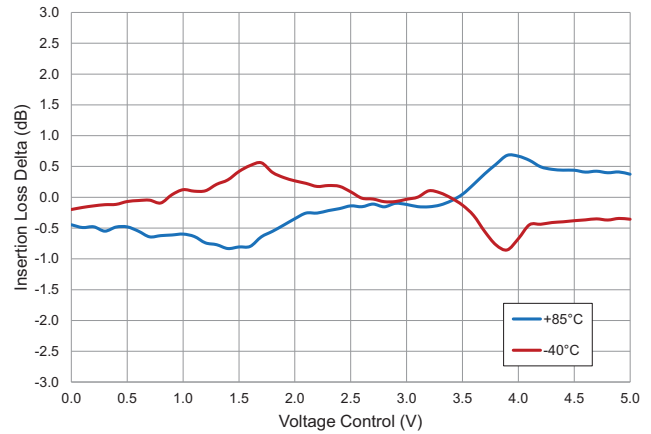

Measured Negative Attenuation Slope Performance

Data includes PCB and connector losses

Insertion Loss versus Voltage Control
RF 2GHz, $V_{DD}=5V$

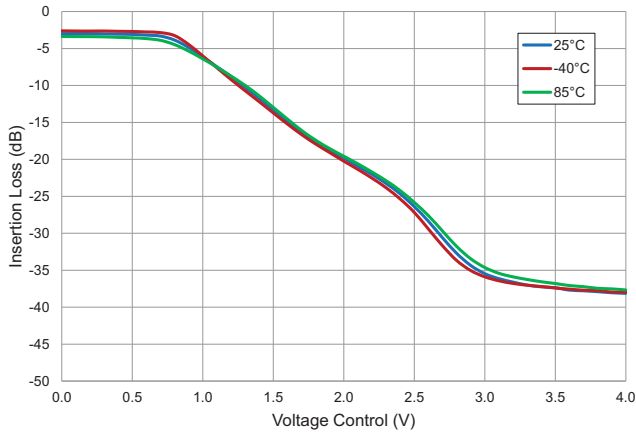

Insertion Loss versus Frequency
 $V_{DD}=5V$, Temp=+25°C

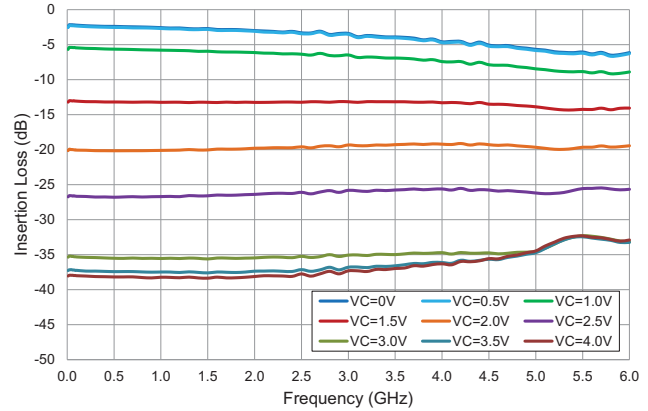

Input Return Loss versus Frequency
RF 2GHz, $V_{DD}=5V$, Temp=+25°C

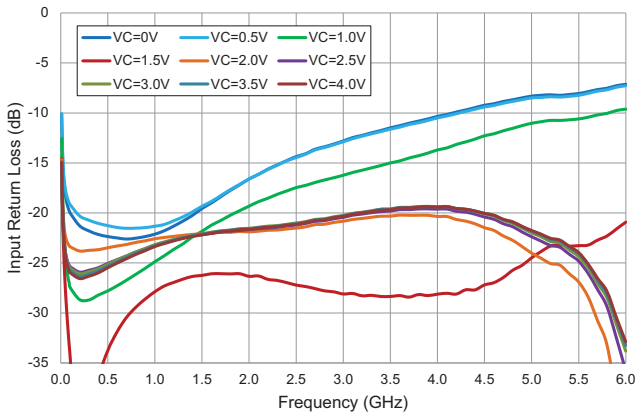

Output Return Loss versus Frequency
RF 2GHz, $V_{DD}=5V$, Temp=+25°C

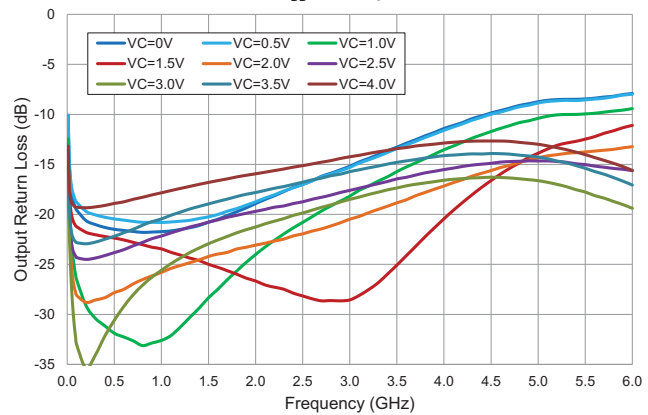

Input Return Loss versus Voltage Control
RF 2GHz, $V_{DD}=5V$

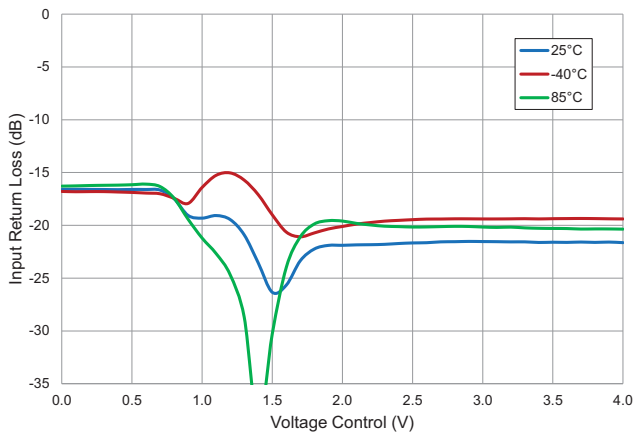

Output Return Loss versus Voltage Control
RF 2GHz, $V_{DD}=5V$

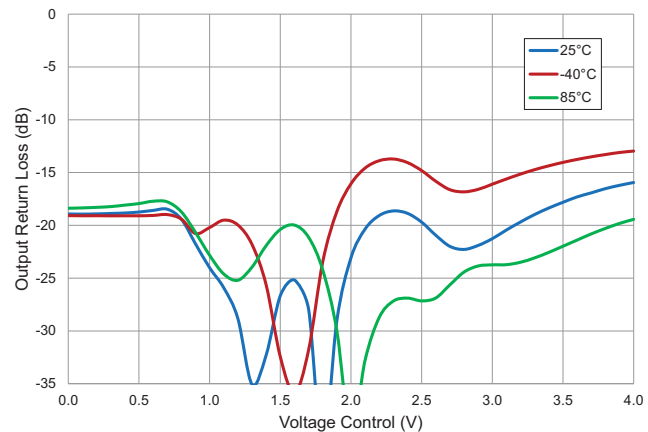

Measured Negative Attenuation Slope Performance

Data includes PCB and connector losses

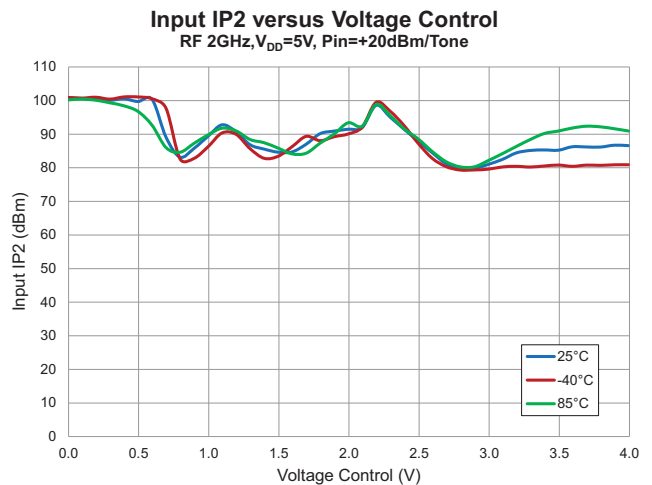
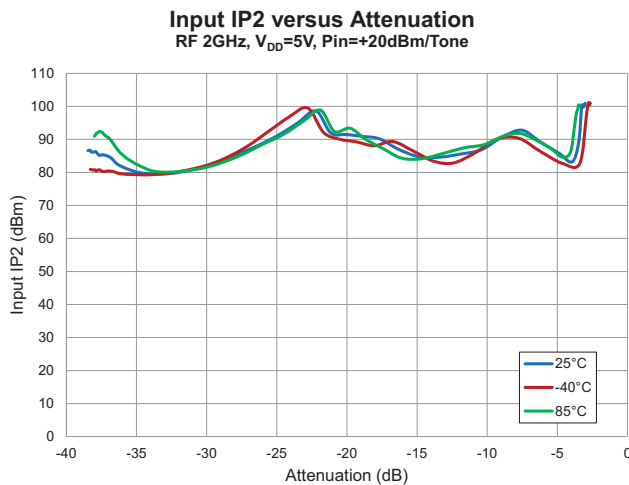
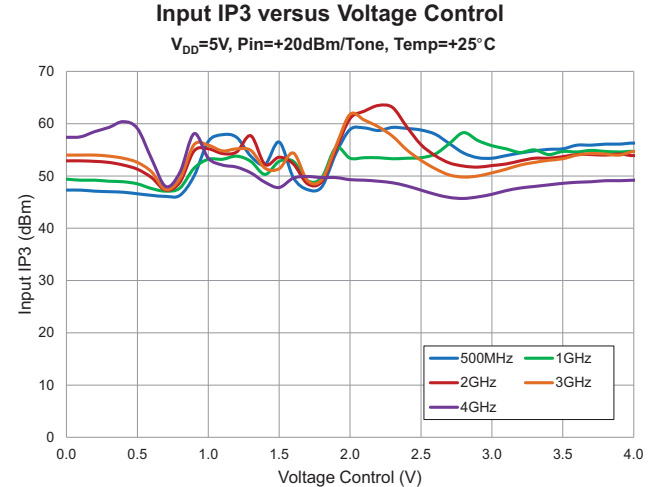
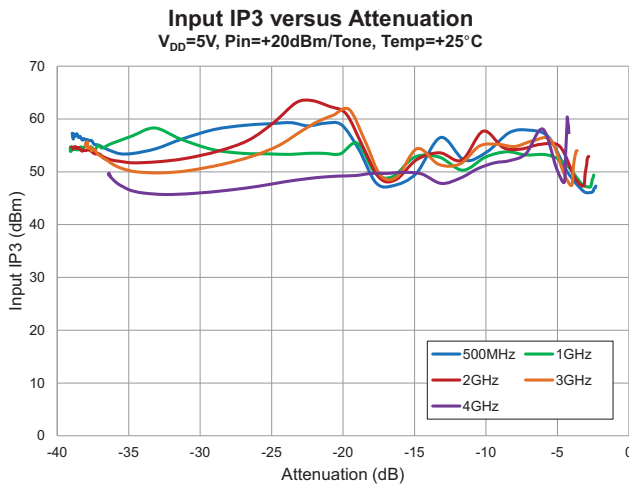
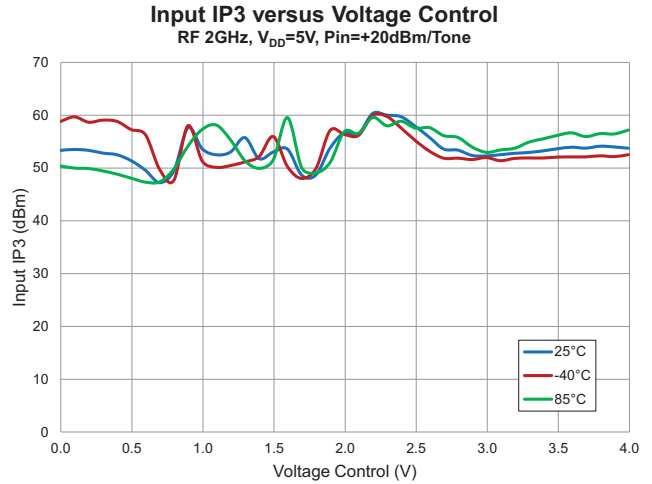
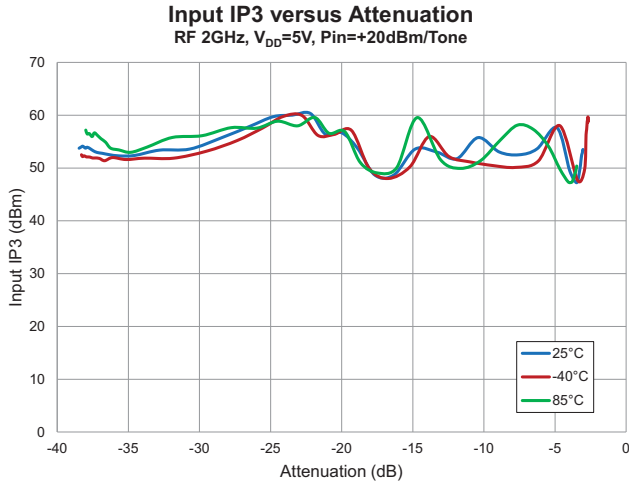

Measured Negative Attenuation Slope Performance

Data includes PCB and connector losses

Input IP2 versus Attenuation
 $V_{DD}=5V$, $P_{in}=+20dBm/Tone$, $Temp=+25^{\circ}C$

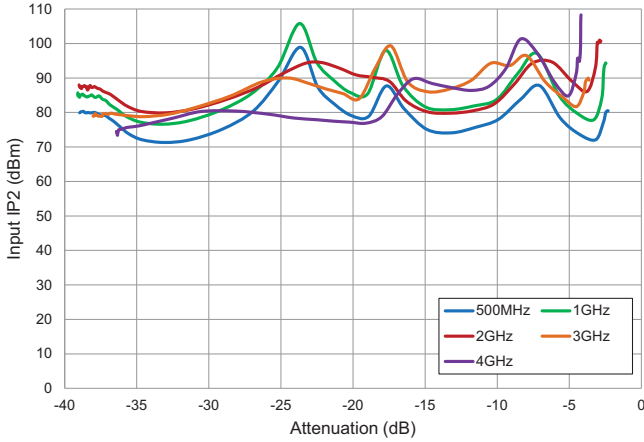

Input IP2 versus Voltage Control
 $V_{DD}=5V$, $P_{in}=+20dBm/Tone$, $Temp=+25^{\circ}C$

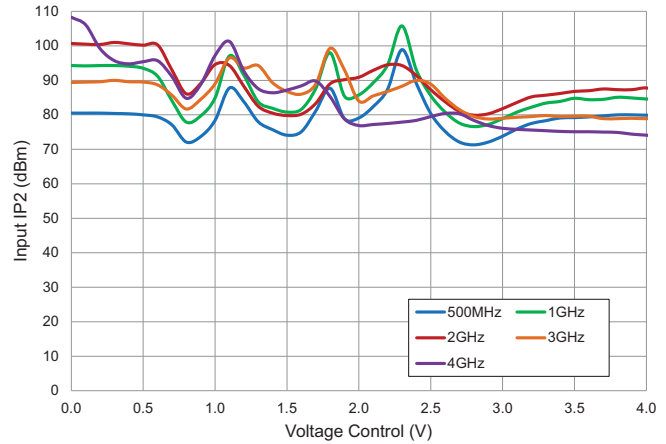

3rd Harmonic IH3 versus Attenuation
 RF 2GHz, $V_{DD}=5V$, $P_{in}=+20dBm$

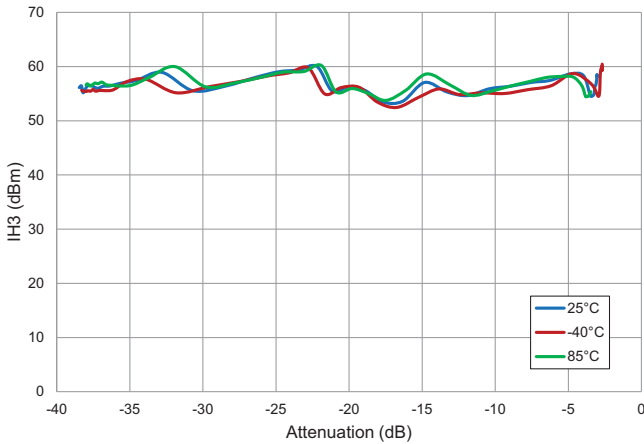

3rd Harmonic IH3 versus Voltage Control
 RF 2GHz, $V_{DD}=5V$, $P_{in}=+20dBm$

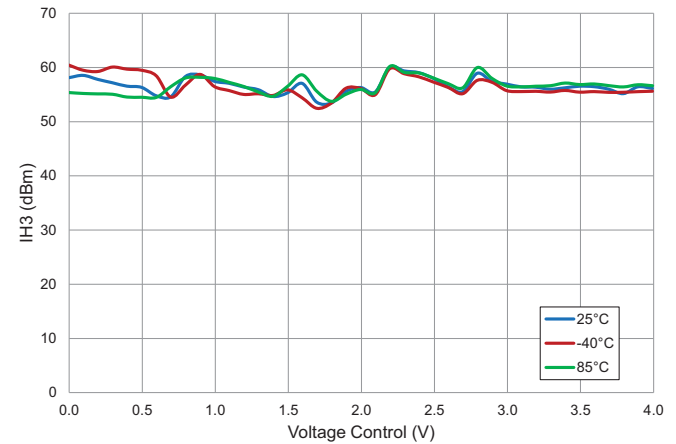

3rd Harmonic IH3 versus Attenuation
 $V_{DD}=5V$, $P_{in}=+20dBm$, $Temp=+25^{\circ}C$

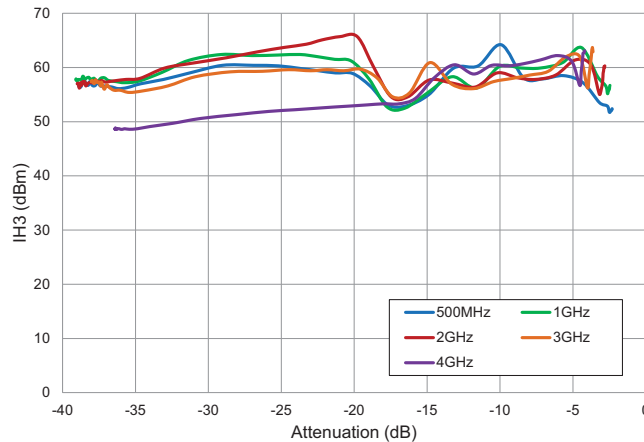

3rd Harmonic IH3 versus Voltage Control
 $V_{DD}=5V$, $P_{in}=+20dBm$, $Temp=+25^{\circ}C$

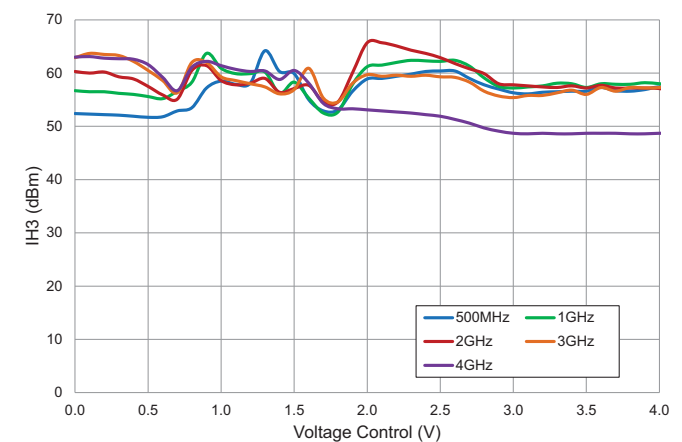

Measured Negative Attenuation Slope Performance

Data includes PCB and connector losses

2nd Harmonic IH2 versus Attenuation
RF 2GHz, V_{DD}=5V, Pin=+20dBm

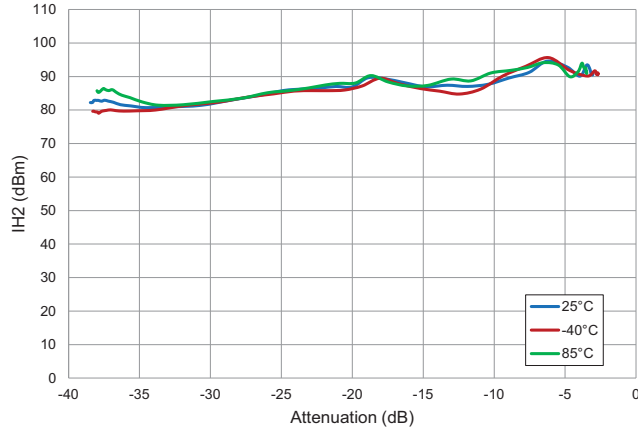

2nd Harmonic IH2 versus Voltage Control
RF 2GHz, V_{DD}=5V, Pin=+20dBm

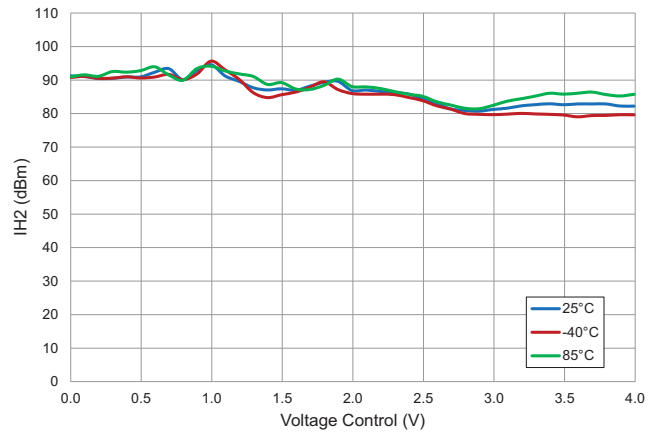

2nd Harmonic IH2 versus Attenuation
V_{DD}=5V, Pin=+20dBm, Temp=+25°C

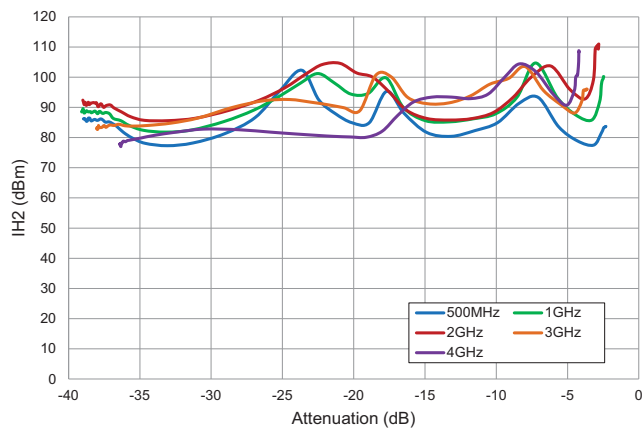

2nd Harmonic IH2 versus Voltage Control
V_{DD}=5V, Pin=+20dBm, Temp=+25°C

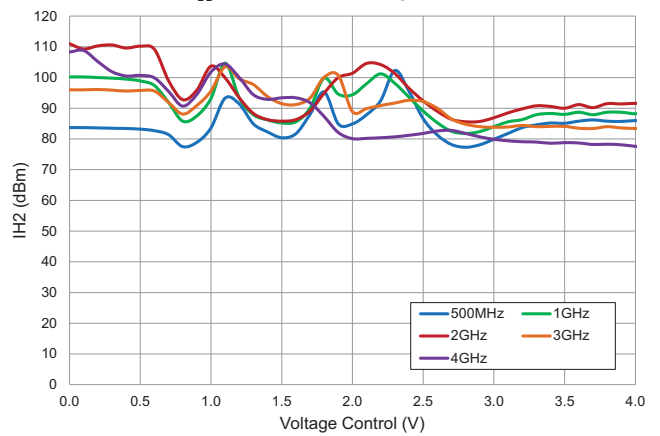

Measured Negative Attenuation Slope Performance

Data includes PCB and connector losses

Relative Insertion Phase versus Voltage Control
RF 2GHz, $V_{DD}=5V$, Temp= $+25^{\circ}C$

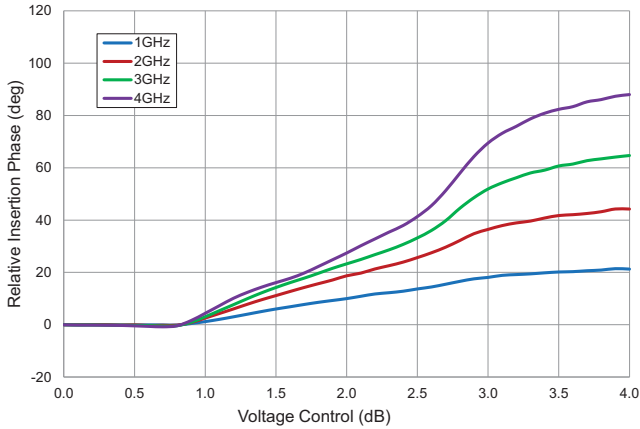

Relative Insertion Phase versus Insertion Loss
RF 2GHz, $V_{DD}=5V$, Temp= $+25^{\circ}C$

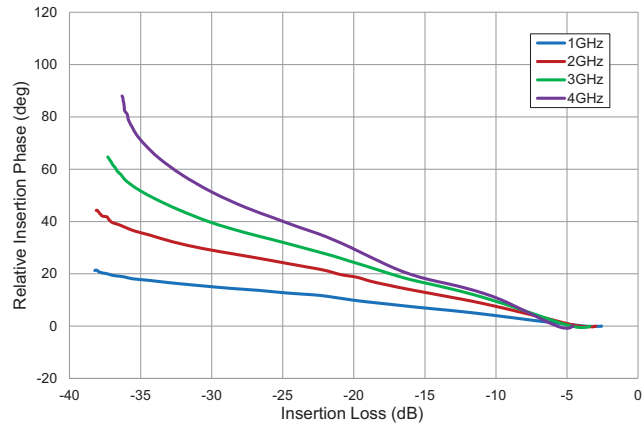

Insertion Loss Relative to $+25^{\circ}C$
RF 2GHz, $V_{DD}=5V$

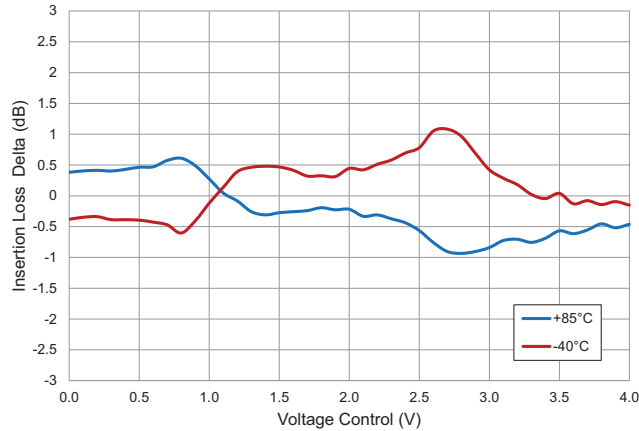

Voltage Control Pin Current Performance

Data includes PCB and connector losses

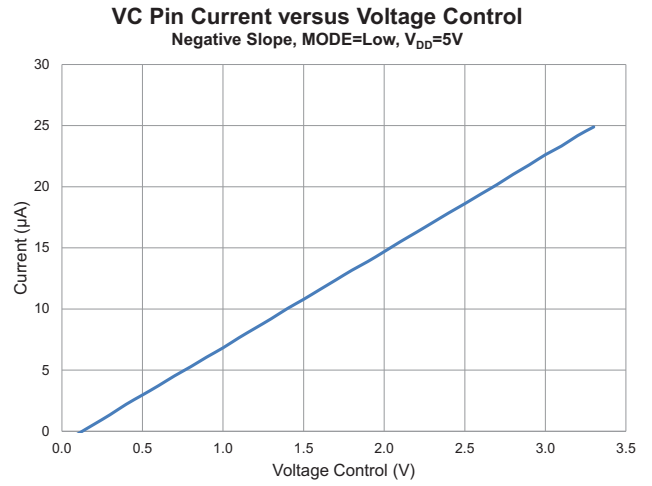
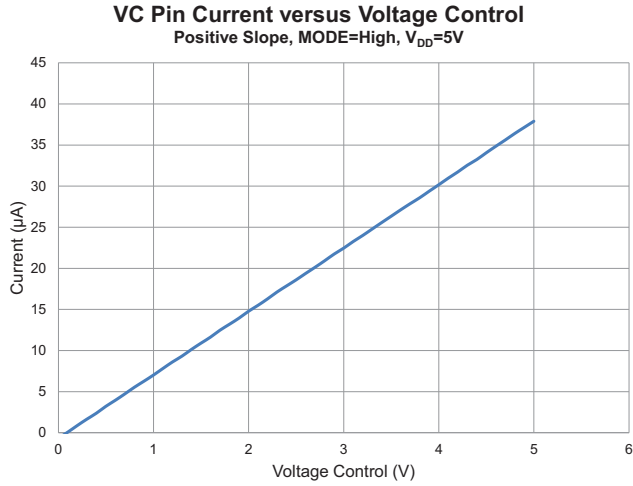

Pin Names and Descriptions

| Pin | Name | Description |
|-----|-------|--|
| 1 | GND | Ground Pin |
| 2 | NC | No Connection. Do Not Connect to PC Board Ground Plane. |
| 3 | RFIN | RF Input. Use External DC Block. RF input must be this pin to insure linearity and thermal resistance specifications. |
| 4 | NC | No Connection. Do Not Connect to PC Board Ground Plane. |
| 5 | GND | Ground Pin |
| 6 | GND | Ground Pin |
| 7 | GND | Ground Pin |
| 8 | GND | Ground Pin |
| 9 | NC | No Connection. Do Not Connect to PC Board Ground Plane. |
| 10 | RFOUT | RF Output. Use External DC Block. RF output must be this pin to insure linearity and thermal resistance specifications. |
| 11 | NC | No Connection. Do Not Connect to PC Board Ground Plane. |
| 12 | GND | Ground Pin |
| 13 | GND | Ground Pin |
| 14 | VC | Attenuator Control Voltage |
| 15 | VDD | Supply Voltage (5V) |
| 16 | MODE | Attenuation Slope Control Set to Logic Low to Enable Negative Attenuation Slope. Set to Logic High to Enable Positive Attenuation Slope. |
| GND | GND | Exposed Package Ground Paddle is RF and DC Ground |

PCB Patterns

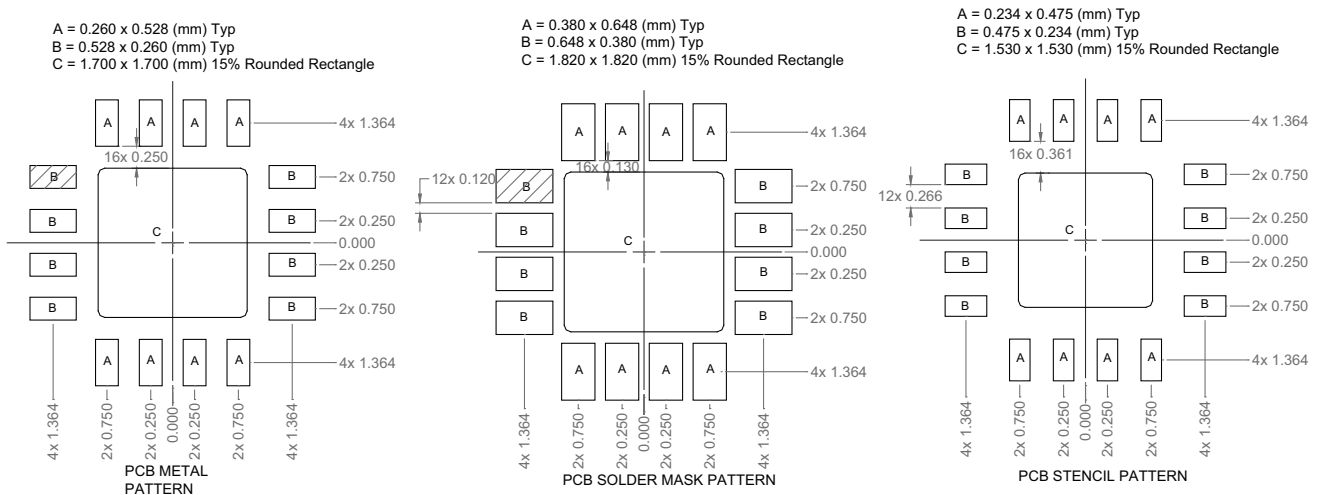

Thermal vias for center slug “C” should be incorporated into the PCB design. The number and size of thermal vias will depend on the application, the power dissipation and the electrical requirements. Example of the number and size of vias can be found on the RFMD evaluation board layout.

Evaluation Board Schematic

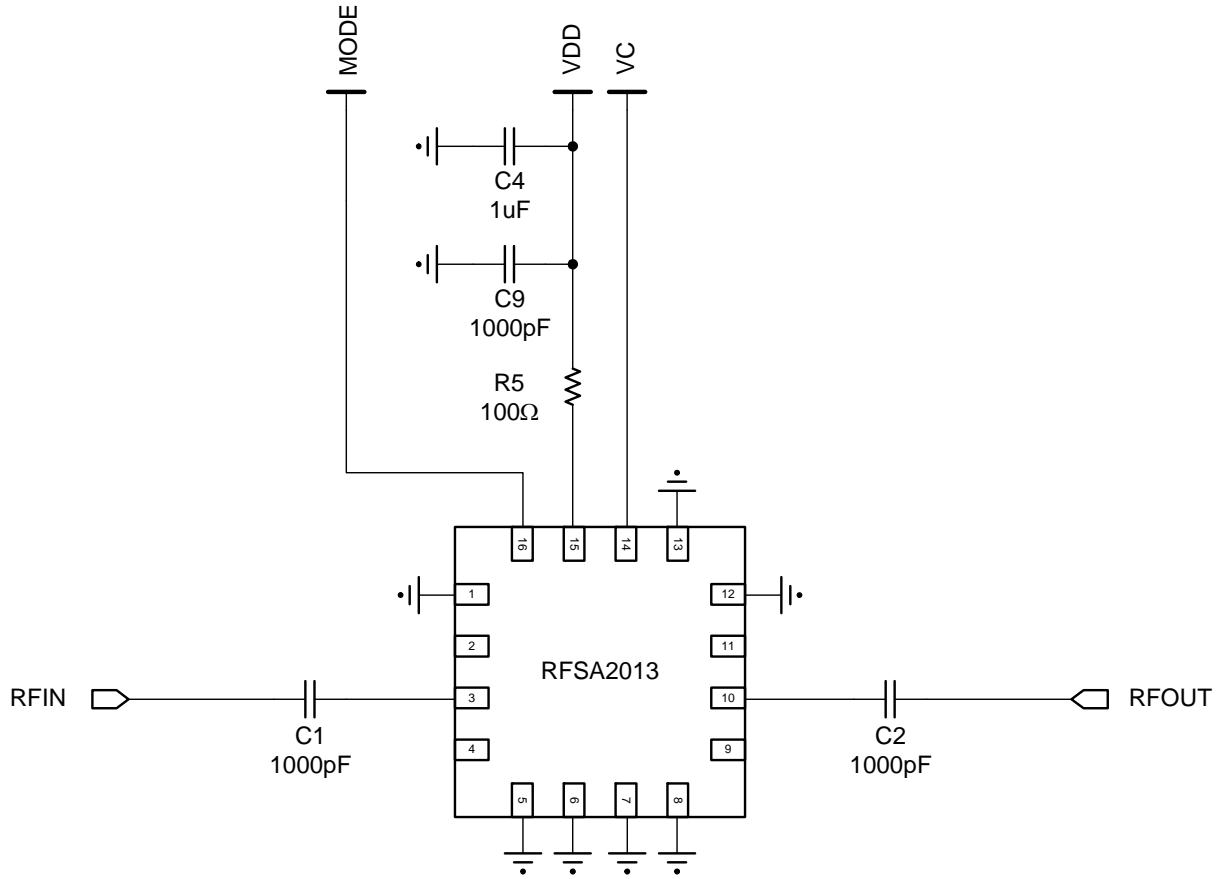

Evaluation Board Assembly Drawing

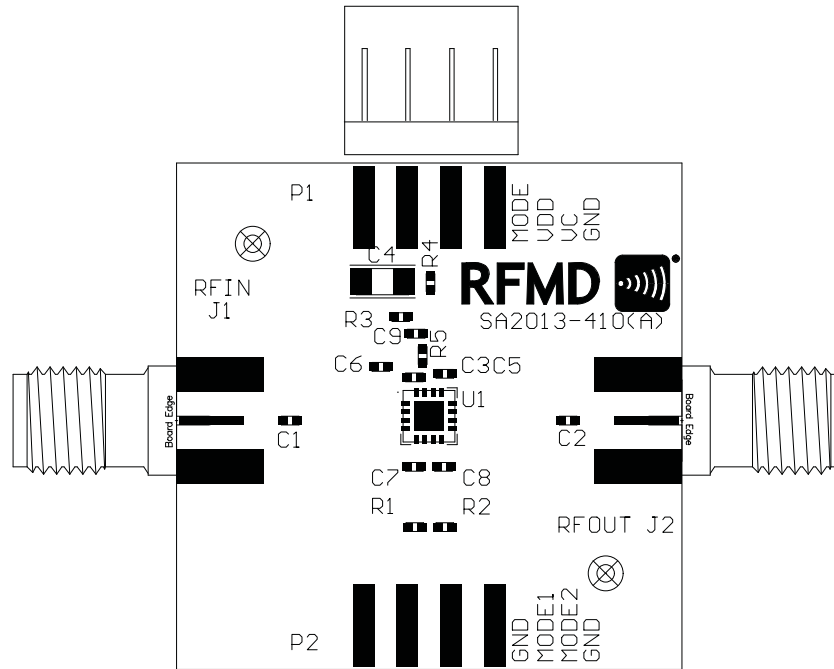

Evaluation Board Bill of Materials (BOM)

| Description | Reference Designator | Manufacturer | Manufacturer's P/N |
|--|----------------------|-----------------------|--------------------|
| Voltage Controlled Attenuator VCA, 5V | U1 | RFMD | RFSA2013 |
| CONN, SMA, END LNCH, MINI, FLT, 0.068" | J1-J2 | Emerson Network Power | 142-0741-851 |
| CONN, HDR, SR, 4-PIN, 0.100", T/H | P1 | MOLEX | 22-28-4043 |
| PCB, SA2013-410 | | DDI | SA2013-410 |
| CAP, 1000pF, 10%, 25V, X7R, 0402 | C1-C2, C9 | Murata Electronics | GRM155R71H102KA01D |
| CAP, 1μF, 10%, 16V, X7R, 1206 | C4 | Murata Electronics | GRM31MR71E105KC01L |
| RES, 100Ω, 5%, 1/16W, 0402 | R5 | Kamaya, Inc | RMC1/16S-101JTH |
| DNP | C3, C5-C8 | N/A | N/A |
| DNP | R1-R4 | N/A | N/A |
| DNP | P2 | N/A | N/A |

Notes:

1. Manufacturers' P/Ns are subject to change by the manufacturers following the issue of this document and are thereby included for reference only.
2. Contact RFMD Corporate Engineering Materials with questions regarding specific Manufacturers' P/Ns.

Package Drawing
(0.9mm x 3mm x 3mm)

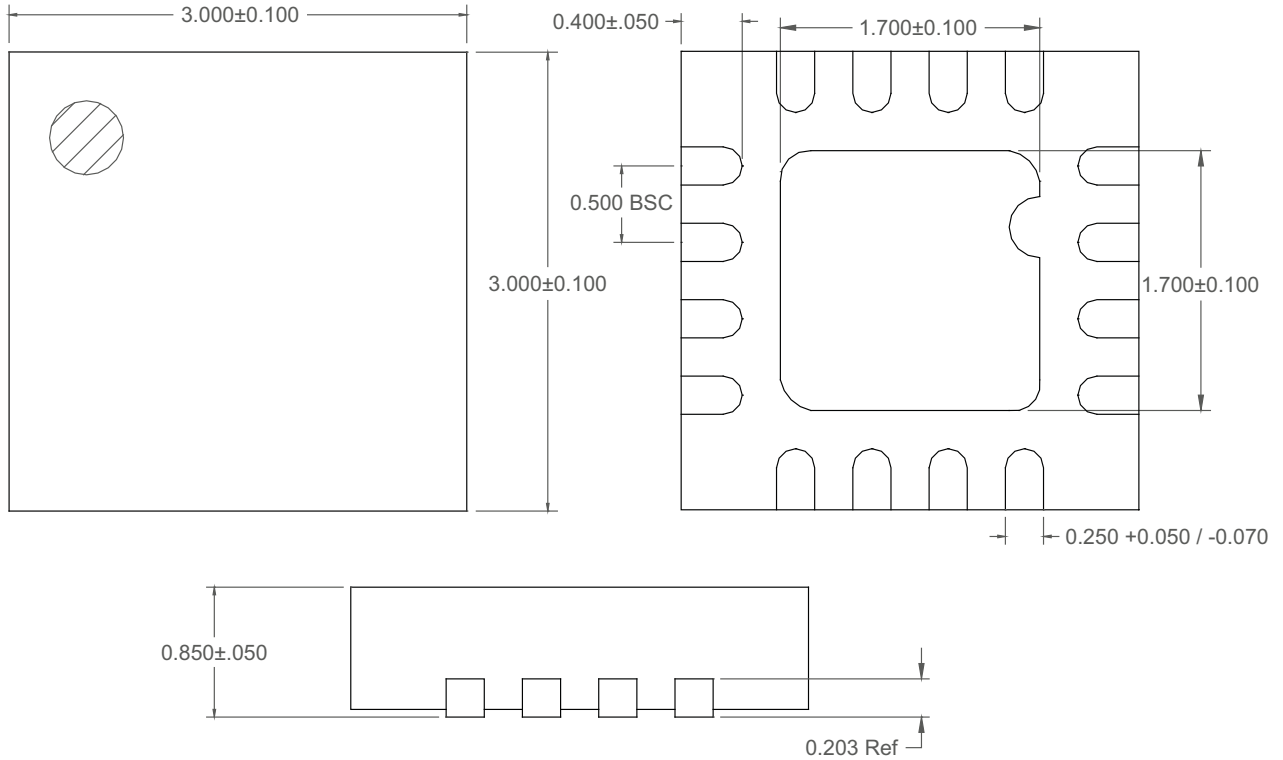

Branding Diagram
(0.9mm x 3mm x 3mm)

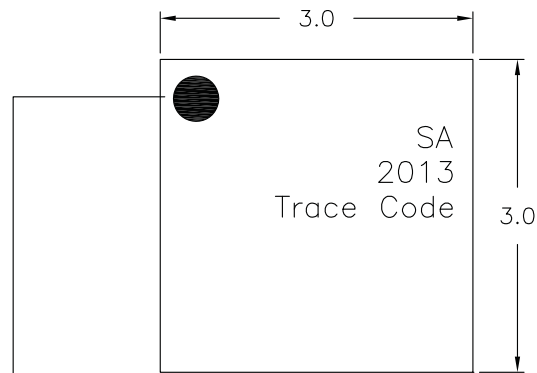

Pin 1 Indicator
Trace Code to be assigned by SubCon