

Thermally-Enhanced High Power RF LDMOS FETs 55 W, 869 – 960 MHz

Description

The PTFA080551E and PTFA080551F are 55-watt, internally matched *GOLDMOS*[®] FETs intended for EDGE and CDMA applications in the 869 to 960 MHz band. Thermally-enhanced packaging provides the coolest operation available. Full gold metallization ensures excellent device lifetime and reliability.

PTFA080551E
Package 30265

PTFA080551F
Package 31265

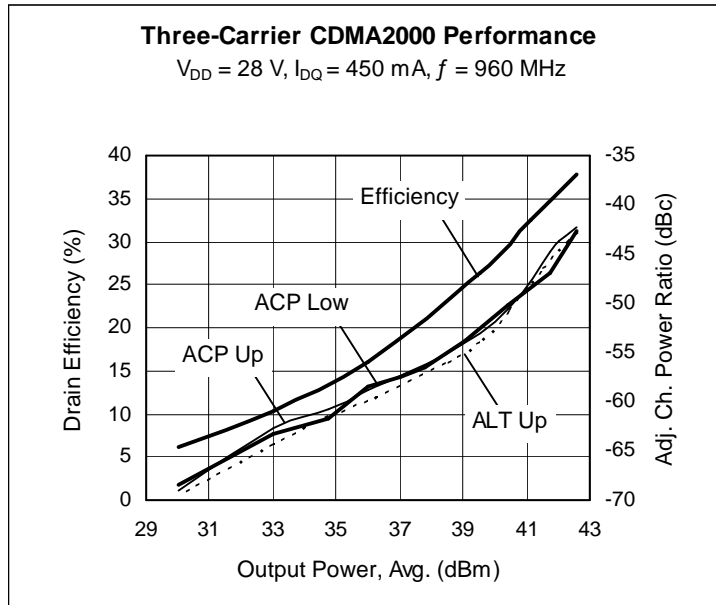
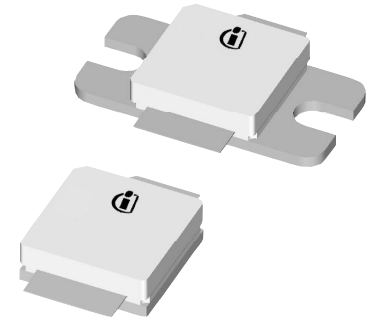

Features

- Broadband internal matching
- Typical EDGE performance
 - Average output power = 26 W
 - Gain = 18 dB
 - Efficiency = 44%
- Typical CW performance
 - Output power at P-1dB = 75 W
 - Gain = 17 dB
 - Efficiency = 67%
- Integrated ESD protection: Human Body Model, Class 2 (minimum)
- Excellent thermal stability, low HCI drift
- Capable of handling 10:1 VSWR @ 28 V, 55 W (CW) output power
- Pb-free and RoHS compliant

RF Characteristics

EDGE Measurements (not subject to production test—verified by design/characterization in Infineon test fixture)

$V_{DD} = 28\text{ V}$, $I_{DQ} = 450\text{ mA}$, $P_{OUT} = 26\text{ W}$, $f = 959.8\text{ MHz}$

Characteristic	Symbol	Min	Typ	Max	Unit
Error Vector Magnitude	EVM (RMS)	—	2.5	—	%
Modulation Spectrum @ 400 kHz	ACPR	—	-60	—	dBc
Modulation Spectrum @ 600 kHz	ACPR	—	-75	—	dBc
Gain	G_{ps}	—	18	—	dB
Drain Efficiency	η_D	—	44	—	%

All published data at $T_{CASE} = 25^\circ\text{C}$ unless otherwise indicated

ESD: Electrostatic discharge sensitive device—observe handling precautions!

RF Characteristics (cont.)

Two-tone Measurements (tested in Infineon test fixture)

 $V_{DD} = 28\text{ V}$, $I_{DQ} = 450\text{ mA}$, $P_{OUT} = 55\text{ W PEP}$, $f = 960\text{ MHz}$, tone spacing = 1 MHz

Characteristic	Symbol	Min	Typ	Max	Unit
Gain	G_{ps}	18	18.5	—	dB
Drain Efficiency	η_D	46.5	48	—	%
Intermodulation Distortion	IMD	—	-31	-29	dBc

DC Characteristics

Characteristic	Conditions	Symbol	Min	Typ	Max	Unit
Drain-Source Breakdown Voltage	$V_{GS} = 0\text{ V}$, $I_{DS} = 10\text{ }\mu\text{A}$	$V_{(BR)DSS}$	65	—	—	V
Drain Leakage Current	$V_{DS} = 28\text{ V}$, $V_{GS} = 0\text{ V}$	I_{DSS}	—	—	1.0	μA
	$V_{DS} = 63\text{ V}$, $V_{GS} = 0\text{ V}$	I_{DSS}	—	—	10.0	μA
On-State Resistance	$V_{GS} = 10\text{ V}$, $V_{DS} = 0.1\text{ V}$	$R_{DS(on)}$	—	0.15	—	Ω
Operating Gate Voltage	$V_{DS} = 28\text{ V}$, $I_{DQ} = 450\text{ mA}$	V_{GS}	2.0	2.3	3.0	V
Gate Leakage Current	$V_{GS} = 10\text{ V}$, $V_{DS} = 0\text{ V}$	I_{GSS}	—	—	1.0	μA

Maximum Ratings

Parameter	Symbol	Value	Unit
Drain-Source Voltage	V_{DSS}	65	V
Gate-Source Voltage	V_{GS}	-0.5 to +12	V
Junction Temperature	T_J	200	$^{\circ}\text{C}$
Total Device Dissipation	P_D	219	W
		Above 25 $^{\circ}\text{C}$ derate by	1.25
Storage Temperature Range	T_{STG}	-40 to +150	$^{\circ}\text{C}$
Thermal Resistance ($T_{CASE} = 70^{\circ}\text{C}$)	$R_{\theta JC}$	0.8	$^{\circ}\text{C/W}$

Ordering Information

Type	Package Outline	Package Description	Marking
PTFA080551E	30265	Thermally-enhanced slotted flange, single-ended	PTFA080551E
PTFA080551F	31265	Thermally-enhanced earless flange, single-ended	PTFA080551F

Typical Performance (data taken in a production test fixture)

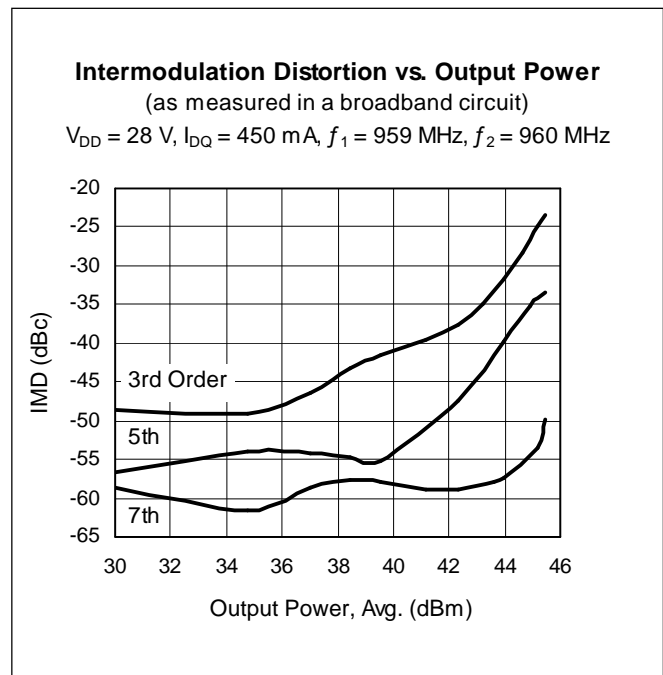
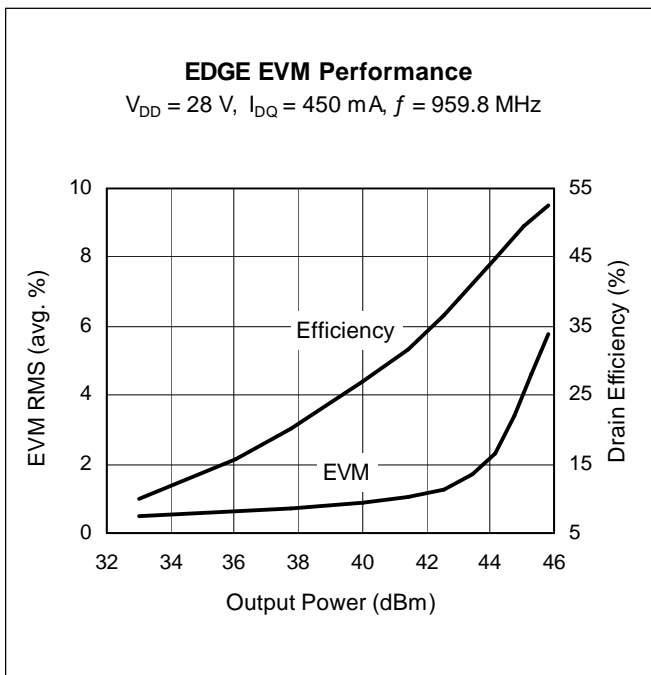
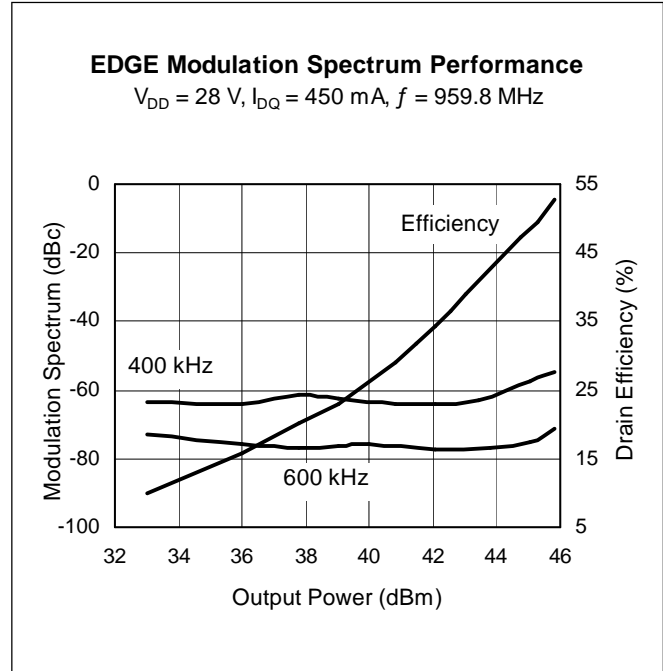
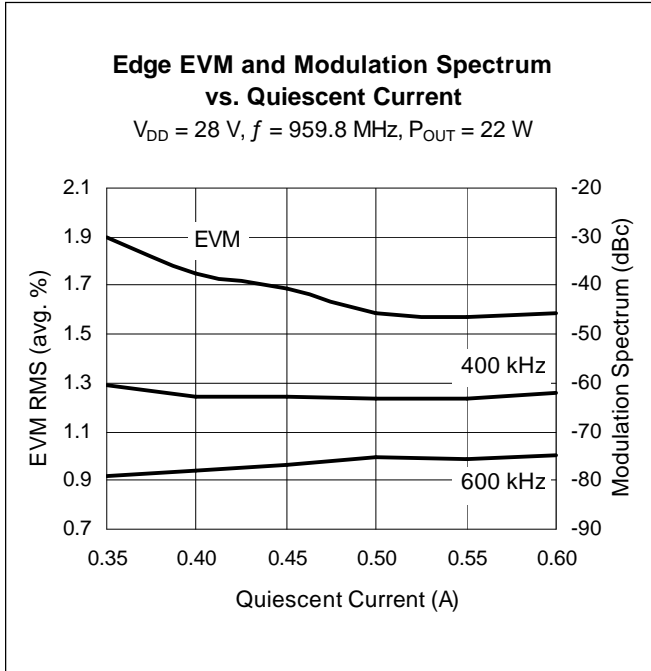

Typical Performance (cont.)

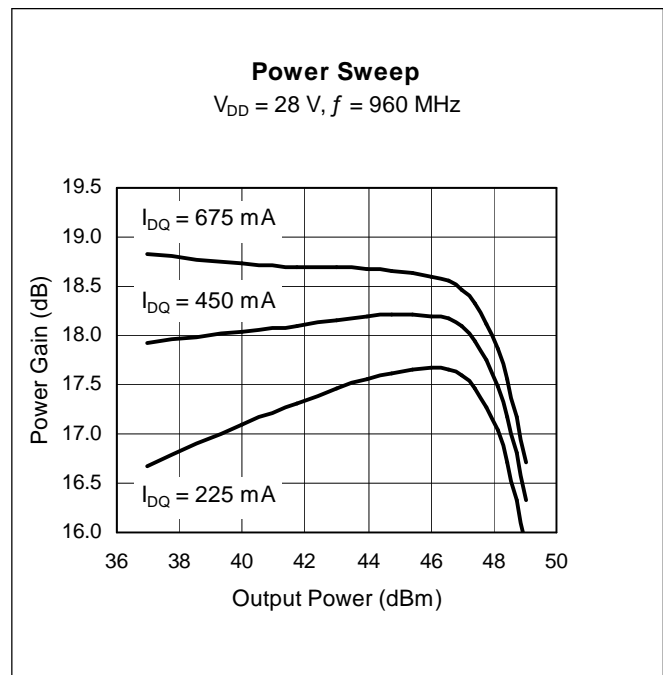
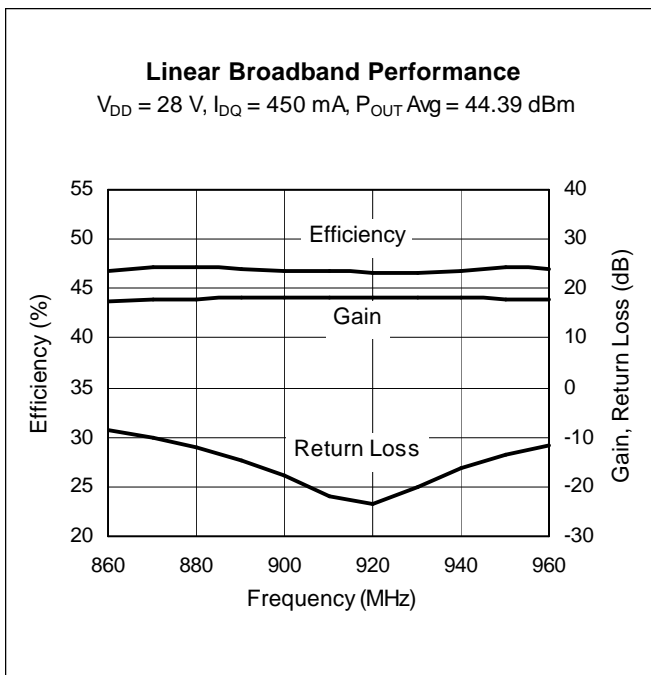
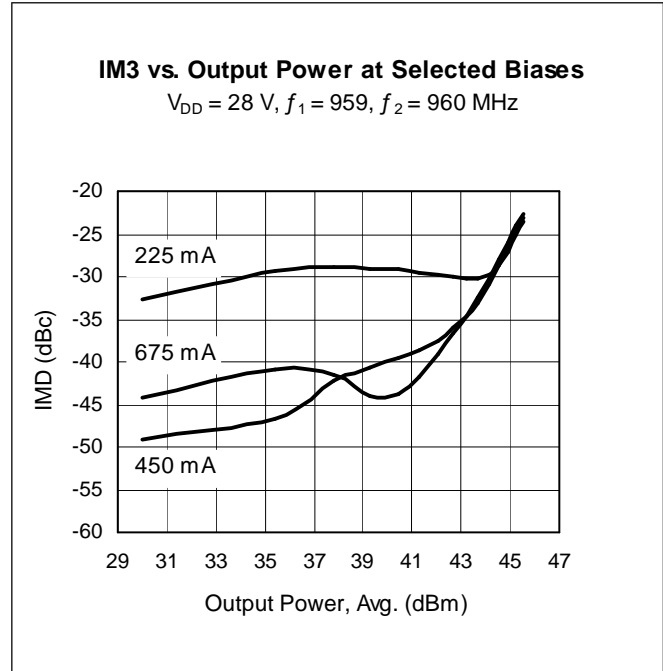
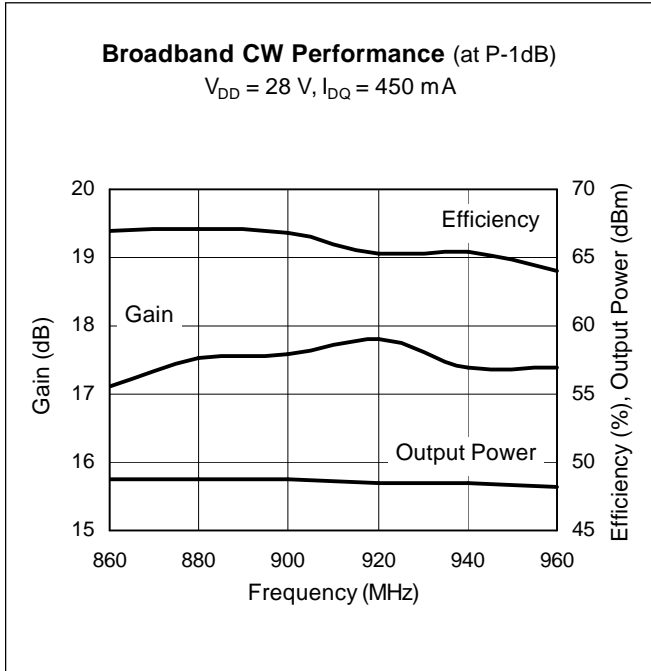

Typical Performance (cont.)

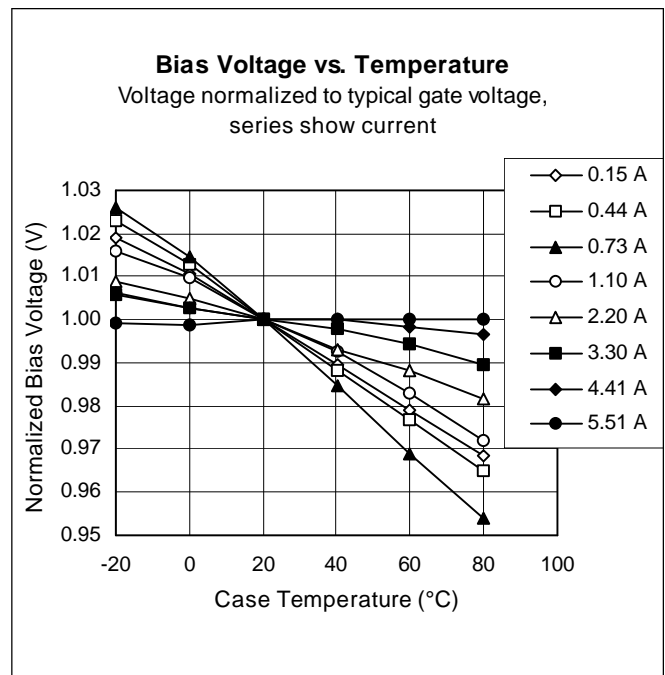
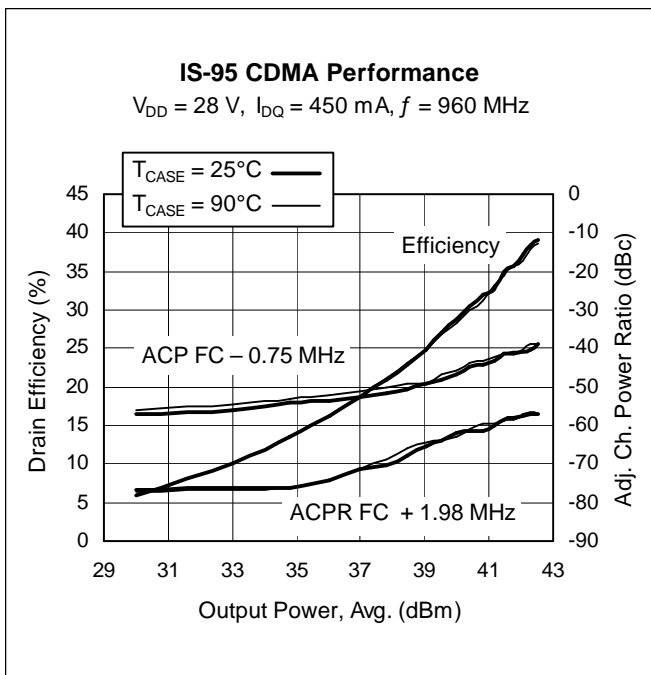
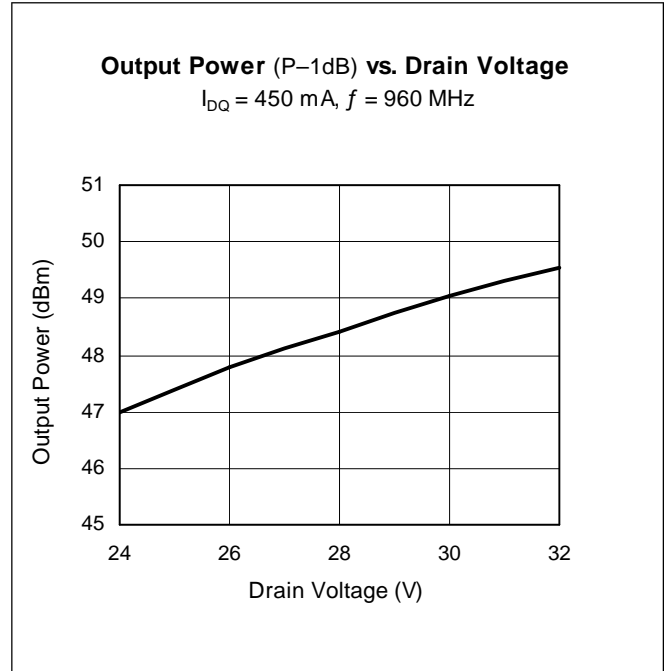
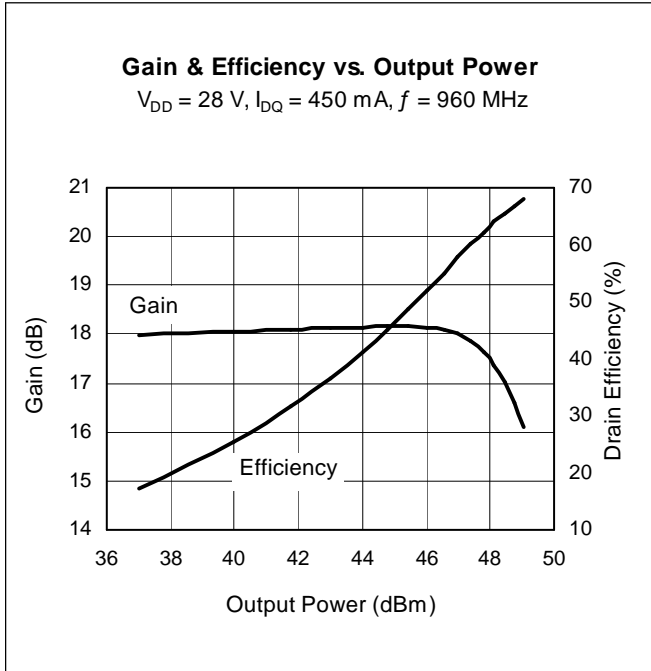

Broadband Circuit Impedance

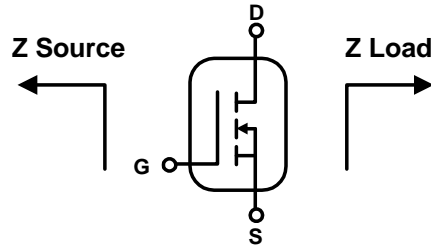

Frequency MHz	Z Source W		Z Load W	
	R	jX	R	jX
869	8.91	-10.93	7.42	-1.63
880	3.72	-8.28	4.65	-1.74
894	5.93	-5.43	4.61	0.16
920	4.87	-7.16	4.88	-0.59
960	6.05	-5.57	4.89	0.86

See next page for circuit information

Reference Circuit

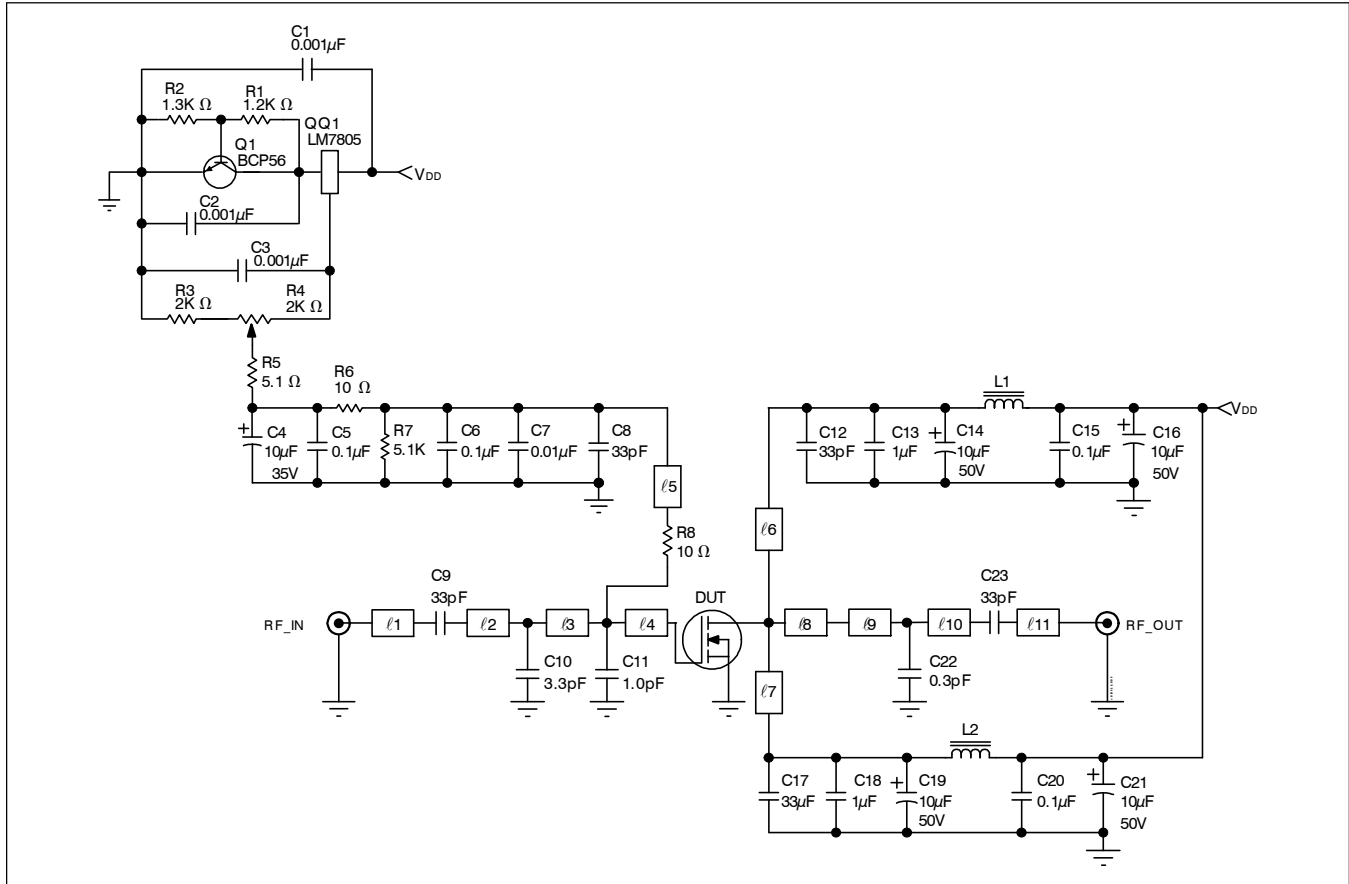

Reference circuit schematic diagram for $f = 960 \text{ MHz}$

Circuit Assembly Information

DUT	PTFA080551E or PTFA080551F	LDMOS Transistor	
PCB	0.76 mm [.030"] thick, $\epsilon_r = 4.5$	Rogers TMM4	2 oz. copper

Microstrip	Electrical Characteristics at 960 MHz ¹	Dimensions: L x W (mm)	Dimensions: L x W (in.)
l_1	0.070λ , 50.0 Ω	12.19 x 1.37	0.480 x 0.054
l_2	0.122λ , 50.0 Ω	20.93 x 1.37	0.824 x 0.054
l_3	0.031λ , 50.0 Ω	5.31 x 1.37	0.209 x 0.054
l_4	0.063λ , 7.5 Ω	9.58 x 16.21	0.377 x 0.638
l_5	0.162λ , 67.0 Ω	28.45 x 0.79	1.120 x 0.031
l_6, l_7	0.150λ , 55.0 Ω	25.65 x 1.17	1.010 x 0.046
l_8	0.198λ , 11.1 Ω	30.73 x 10.46	1.210 x 0.412
l_9	0.145λ , 38.0 Ω	24.21 x 2.16	0.953 x 0.085
l_{10}	0.009λ , 38.0 Ω	1.52 x 2.16	0.060 x 0.085
l_{11}	0.026λ , 50.0 Ω	4.50 x 1.37	0.177 x 0.054

¹Electrical characteristics are rounded.

Reference Circuit (cont.)

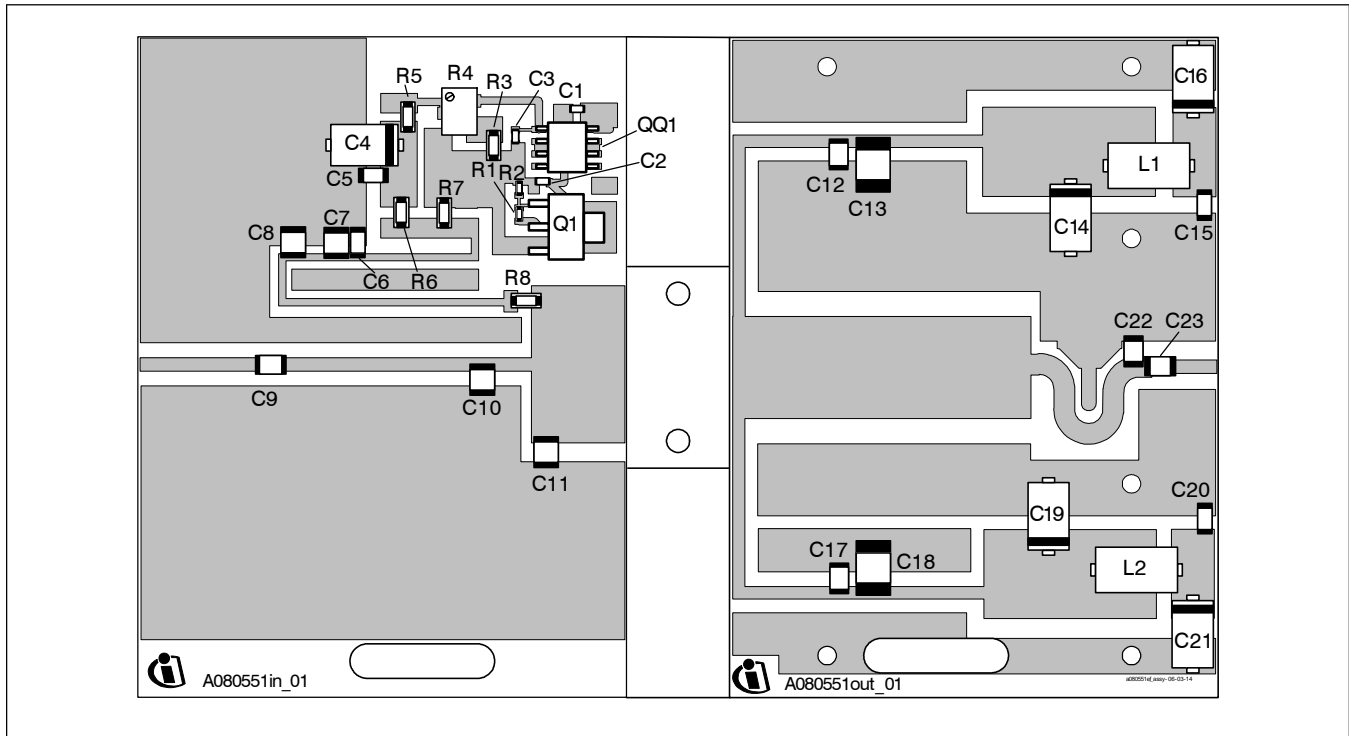

Reference circuit assembly diagram (not to scale)*

Component	Description	Suggested Manufacturer	P/N or Comment
C1, C2, C3	Capacitor, 0.001 μ F	Digi-Key	PCC1772CT-ND
C4	Tantalum capacitor, 10 μ F, 35 V	Digi-Key	399-1655-2-ND
C5, C6, C15, C20	Capacitor, 0.1 μ F	Digi-Key	PCC104BCT-ND
C8, C9, C12, C17, C23	Ceramic capacitor, 33 pF	ATC	100B 330
C7	Capacitor, 0.01 μ F	ATC	200B 103
C10	Ceramic capacitor, 3.3 pF	ATC	100B 3R3
C11	Ceramic capacitor, 1.0 pF	ATC	100B 1R0
C13, C18	Capacitor, 1.0 μ F	ATC	920C105
C14, C16, C19, C21	Tantalum capacitor, 10 μ F, 50 V	Garrett Electronics	TPSE106K050R0400
C22	Ceramic capacitor, 0.3 pF	ATC	100B 0R3
L1, L2	Ferrite, 8.9 mm	Elna Magnetics	BDS 4.6/3/8.9-4S2
Q1	Transistor	Infinion Technologies	BCP56
QQ1	Voltage regulator	National Semiconductor	LM7805
R1	Chip Resistor 1.2 k-ohms	Digi-Key	P1.2KGCT-ND
R2	Chip Resistor 1.3 k-ohms	Digi-Key	P1.3KGCT-ND
R3	Chip Resistor 2 k-ohms	Digi-Key	P2KECT-ND
R4	Potentiometer 2 k-ohms	Digi-Key	3224W-202ETR-ND
R5, R7	Chip Resistor 5.1 k-ohms	Digi-Key	P5.1KECT-ND
R6, R8	Chip Resistor 10 ohms	Digi-Key	P10ECT-ND

*Gerber Files for this circuit available on request

Package Outline Specifications

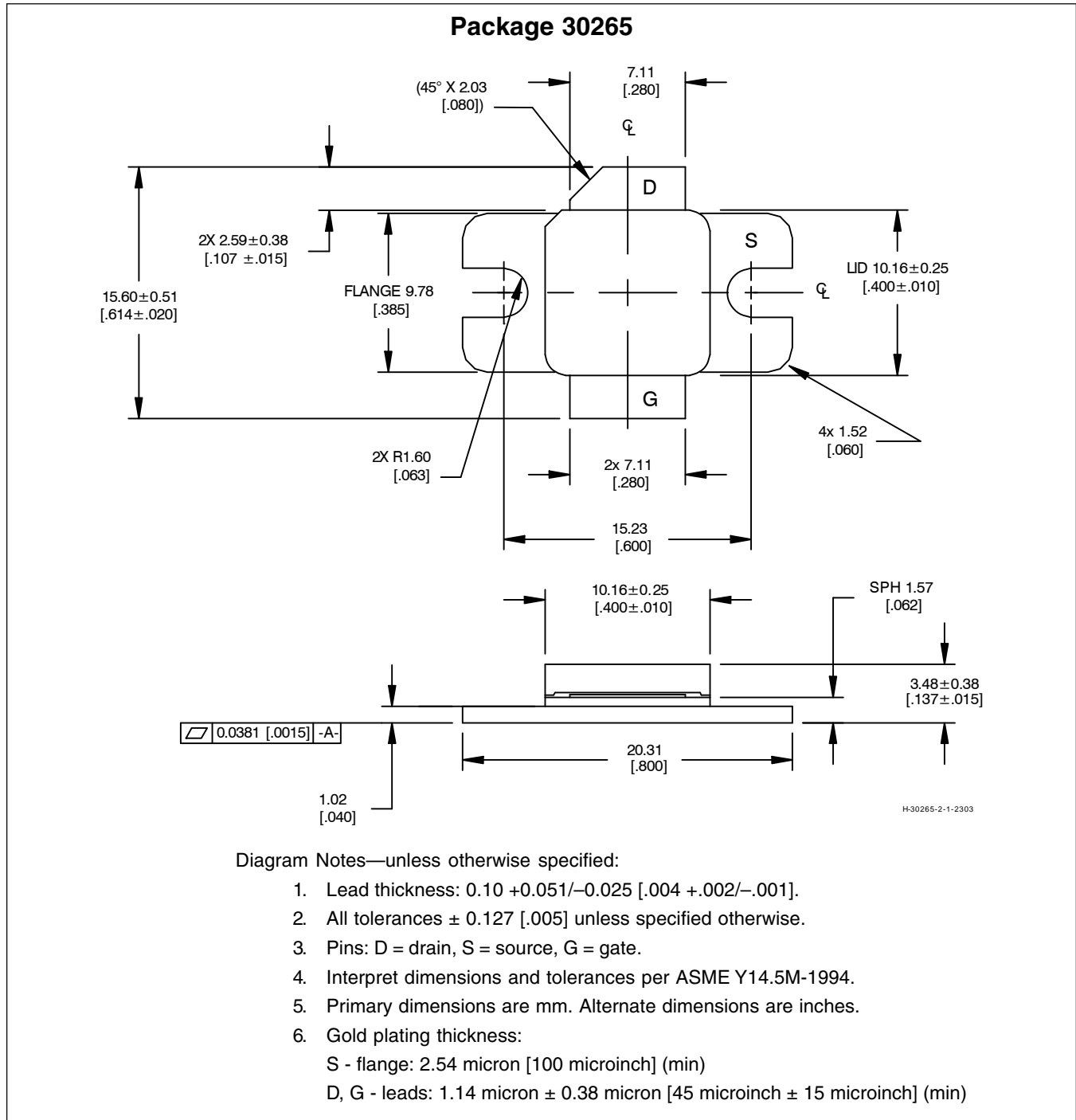

Find the latest and most complete information about products and packaging at the Infineon Internet page
<http://www.infineon.com/products>

Package Outline Specifications (cont.)

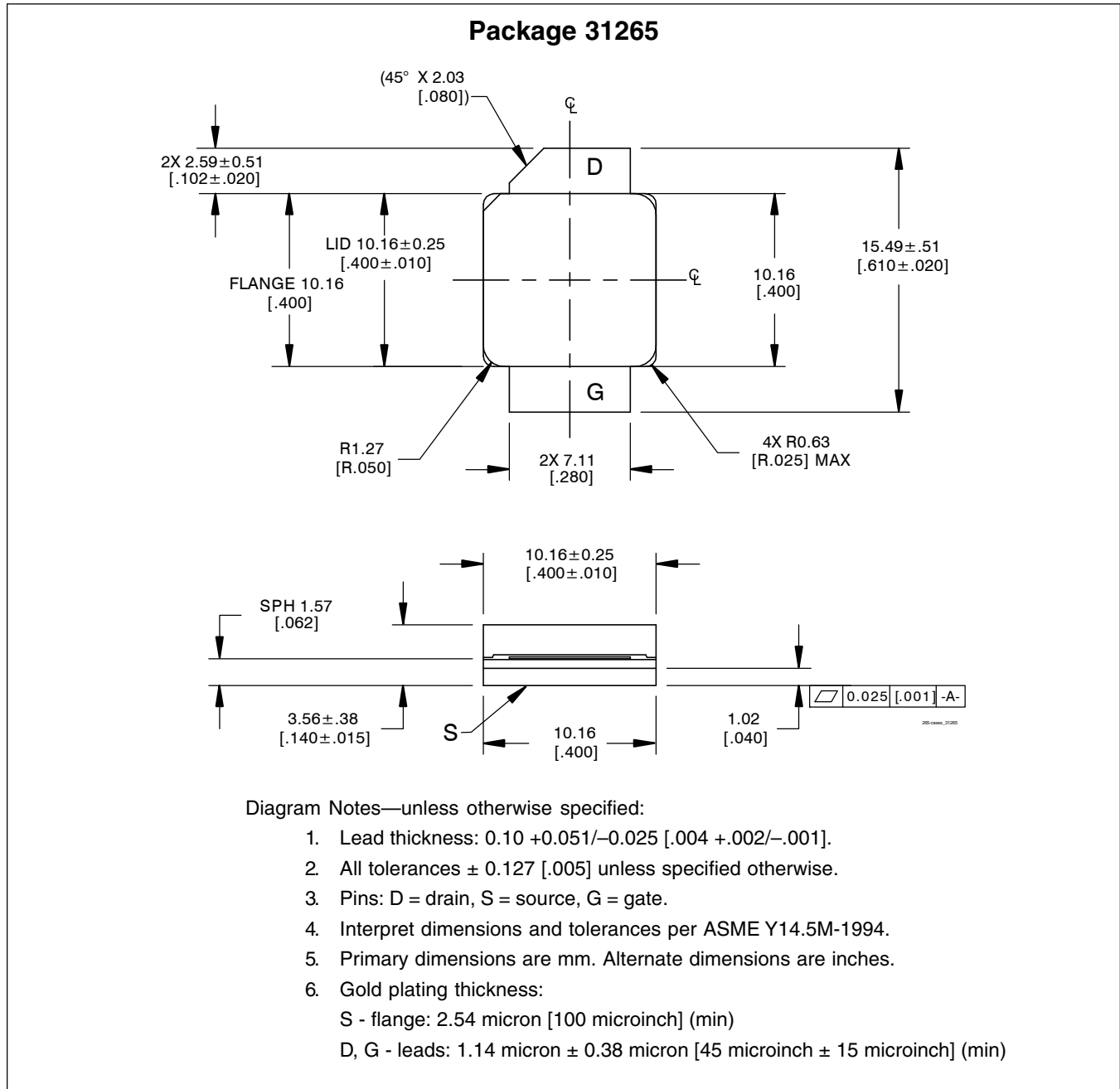

Find the latest and most complete information about products and packaging at the Infineon Internet page
<http://www.infineon.com/products>

Page	Subjects (major changes since last revision)

We Listen to Your Comments

Any information within this document that you feel is wrong, unclear or missing at all?

Your feedback will help us to continuously improve the quality of this document.

Please send your proposal (including a reference to this document) to:

highpowerRF@infineon.com

To request other information, contact us at:
+1 877 465 3667 (1-877-GOLDMOS) USA
or +1 408 776 0600 International

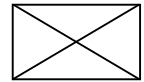

GOLDMOS[®] is a registered trademark of Infineon Technologies AG.

Edition 2006-03-16

**Published by Infineon Technologies AG,
St.-Martin-Strasse 53,
81669 München, Germany**

**© Infineon Technologies AG 2006.
All Rights Reserved.**

Attention please!

The information herein is given to describe certain components and shall not be considered as a guarantee of characteristics.

Terms of delivery and rights to technical change reserved.

We hereby disclaim any and all warranties, including but not limited to warranties of non-infringement, regarding circuits, descriptions and charts stated herein.

Information

For further information on technology, delivery terms and conditions and prices please contact your nearest Infineon Technologies Office (www.infineon.com/rfpower).

Warnings

Due to technical requirements components may contain dangerous substances. For information on the types in question please contact your nearest Infineon Technologies Office.

Infineon Technologies Components may only be used in life-support devices or systems with the express written approval of Infineon Technologies, if a failure of such components can reasonably be expected to cause the failure of that life-support device or system, or to affect the safety or effectiveness of that device or system. Life support devices or systems are intended to be implanted in the human body, or to support and/or maintain and sustain and/or protect human life. If they fail, it is reasonable to assume that the health of the user or other persons may be endangered.